

Manual of

Best Practices

for the Prevention of Corrosion on Vehicles and
Equipment used by Transportation Agencies for
Snow and Ice Control

April 2015



Prepared by:

Mehdi Honarvar Nazari
Dave Bergner
Xianming Shi

Western Transportation Institute
Montana State University

Published by:

Minnesota Department of Transportation
Research Services & Library
395 John Ireland Boulevard, MS 330
St. Paul, Minnesota 55155-1899



Manual of Best Practices for the Prevention of Corrosion on Vehicles and Equipment used by Transportation Agencies for Snow and Ice Control



Prepared by:

Mehdi Honarvar Nazari
Dave Bergner
Xianming Shi

Western Transportation Institute
Montana State University
2015

Published by:

Minnesota Department of Transportation
Research Services & Library
395 John Ireland Boulevard, MS 330
St. Paul, Minnesota 55155-1899

This manual represents the results of research conducted by the authors and does not necessarily represent the views or policies of the Minnesota Department of Transportation and/or (author's organization). This manual report does not contain a standard or specified technique.

The authors and the Minnesota Department of Transportation and/or (author's organization) do not endorse products or manufacturers. Trade or manufacturers' names appear herein solely because they are considered essential to this manual.

Report Overview and Organization

This manual presents ideas and innovations that can be readily implemented. The target audience for this manual is line managers responsible for fleet maintenance and/or snow and ice control operations, but can be used as an information source for vehicle operators and upper management. The manual presents a comprehensive summary of how and why corrosion occurs, the direct and indirect costs of the effects, and practical, feasible ways to prevent and remedy corrosion.

Chapters 1-4 provides background on corrosion types and causes and will be of **general interest to all readers**.

Chapters 5,6, and 8 offer most benefit to **fleet managers**.

Chapters 6, 7, and 8 offer the most benefit to **garage supervisors and staff**.

Table of Contents

CHAPTER 1: INTRODUCTION	1
CHAPTER 2: CORROSION DEFINED – RUST NEVER SLEEPS	3
2.1 GENERAL CORROSION	3
2.2 LOCALIZED CORROSION.....	4
2.2.1 Pitting Corrosion	5
2.2.2 Crevice corrosion.....	5
2.2.3 Filiform Corrosion.....	6
2.2.4 Intergranular corrosion	7
2.2.5 Galvanic corrosion.....	8
2.2.6 Stress Corrosion Cracking (SCC)	9
2.2.7 Corrosion Fatigue.....	9
2.2.8 Erosion Corrosion	11
2.2.9 Fretting Corrosion	12
2.2.10 Microbially Influenced Corrosion (MIC).....	13
CHAPTER 3: CAUSES AND EFFECTS OF CORROSION	14
3.1. CORROSION-PRONE PARTS ON DOT EQUIPMENT	15
3.2. EFFECT OF DEICERS ON METALS, INFRASTRUCTURE AND ENVIRONMENT.....	17
3.3. COMMON DEICERS EXPOSED TO VEHICLES AND EQUIPMENT	20
3.4. ANNUAL EXPENDITURES TO MANAGE DEICER CORROSION OF VEHICLES/EQUIPMENT.....	21
3.5. RISKS OF DEICER CORROSION TO THE EQUIPMENT FLEET.....	24
3.6. METALLIC CORROSION ON TYPES OF EQUIPMENT AND COMPONENTS.....	25
3.7. COMMON TYPES OF CORROSION-PRONE MATERIAL AND THEIR RESPECTIVE FORMS OF CORROSION.....	29
3.8. COST-BENEFIT ANALYSIS OF MITIGATING DEICER CORROSION TO DOT EQUIPMENT	29
3.9. SUPPLEMENTAL INFORMATION.....	30
3.9.1 Chloride Deicer Corrosion Problem	30
3.9.2 Chloride Deicer Corrosion Causes.....	30
CHAPTER 4: MATERIALS USED FOR SNOW AND ICE CONTROL	32
CHAPTER 5: NEW EQUIPMENT SPECIFICATION – BUILD TO LAST	34
5.1. METAL MATERIALS SELECTION.....	34
5.2. DESIGN IMPROVEMENTS.....	36
5.3. CONSIDERATIONS FOR WELDED JOINTS.....	43
5.4. COATINGS FOR CORROSION PROTECTION (ANTI-CORROSION COATINGS)	44
5.4.1 Surface preparation methods prior to coating.....	45
5.4.2 Reapplication of Coatings	47
5.4.3 A Successful Plan for Recoating	47
CHAPTER 6: REPAIR, REHABILITATION AND RETROFITTING OF EXISTING EQUIPMENT	50
6.1. EVALUATION PROCESS FOR FLEET VEHICLES	50
6.2. REPAIR AND RESTORATION PROCESS	51

6.2.1 Removal of Rust and Corrosion	51
6.2.2 Modifications	53
CHAPTER 7: PREVENTIVE MAINTENANCE PRACTICES FOR EQUIPMENT	54
7.1. OPERATOR INSPECTIONS - IN-SEASON AND POST-SEASON	54
7.1.1 Tips to Protect Your Snowplow From Corrosion	55
7.1.2 Snow Plow Storage	56
7.1.3 Avoiding plow breakdowns	56
7.2. MECHANIC INSPECTIONS – ROUTINE AND SPECIAL	58
7.3. SUPERVISOR CHECKS	58
7.4. PLOWING, SPREADING AND SPRAYING METHODS AND TECHNIQUES	59
7.5. POST-STORM CLEANUP; PROCESSES AND PRODUCTS	59
7.5.1 Inhibitors for Corrosion Protection	60
7.5.2 Washing	62
7.5.3 Proactive Methods for Diminishing Corrosion	64
7.5.4 Practical examples	66
7.5.5 Operational Methods to Mitigate Corrosion on Existing Equipment	71
7.5.6 Maintenance Programs	72
7.5.7 Recent progress and advancements	75
CHAPTER 8: TRAINING AND FACILITY MANAGEMENT	79
8.1. OPERATOR TRAINING	79
8.2. MECHANIC TRAINING	79
8.3. MANAGEMENT RESPONSIBILITIES	79
8.4. FACILITIES	79
REFERENCES	81
APPENDIX A: LISTS OF FIGURES AND TABLES	92
APPENDIX B: TEST METHODS AND ONLINE MONITORING TECHNIQUES FOR ANTI-CORROSION PRACTICES	98
B.1. TEST METHODS	98
B.1.1. Salt spray	98
B.1.2 ASTM standard B117 and SAE J2334	100
B.1.3 ISO 20430 and ASTM D5894	102
B.1.4 PNS/NACE	103
B.1.5 SHRP H-205.7	104
B.1.6 Durability test	104
B.1.7 ASTM D610	106
B.1.8 ASTM D714	109
B.1.9 ASTM D2244	111
B.1.10 Contact Angle Measurements	111
B.1.11 ASTM D1654	111
B.1.12 ASTM D523	112
B.1.13 Visual examination	113

<i>B.1.14 Field Test Kits</i>	113
B.2. ONLINE MONITORING.....	113
<i>B.2.1 Wire Beam Electrode (WBE)</i>	114
<i>B.2.2 Coupled multielectrode corrosion sensors</i>	116
<i>B.2.3 Impedance sensors</i>	117
<i>B.2.4 Bimetallic corrosion sensor</i>	118
APPENDIX C. U.S. MARINE CORPS CORROSION PREVENTION & CONTROL PLAN	121
C.1. CORROSION CATEGORY CODE DEFINITIONS	121
C.2. INSPECTION TOOL AND DATABASE	122
C.3. CORROSION REPAIR AND FACILITIES	123
C.4. CORROSION PREVENTION.....	125
C.5. CONTRACT WORDING	126
C.6. CPCP EXAMPLE: JOINT LIGHT TACTICAL VEHICLE (JLTV)	127
APPENDIX D. FLEET COMPOSITION AND REPLACEMENT EXAMPLE AUDIT	131
APPENDIX E. ADDITIONAL PRACTICAL EXAMPLES OF REPLACED OR MODIFIED EQUIPMENT TO REDUCE CORROSION.....	133

Chapter 1: Introduction

Most regions in the United States experience snow and ice storms to some degree each year. The Northwest, Mountain West, Great Plains, Midwest, Great Lakes, Central States, and the Northeast routinely experience winter storms. Though typically considered “desert,” the high country in northern Arizona and New Mexico also receive significant snowfall. State, county, municipal, tribal, and special district transportation entities in these “snow belt” areas have fleets of vehicles and equipment used to plow and treat roadways and airport runways. Materials used for anti-icing (proactive prevention of ice bonding to pavement) and de-icing (reactive breaking of the ice and pavement bond) are used extensively to keep roadways, runways, and parking lots safely passable. The most commonly used materials, such as rock salt and calcium chloride, are highly corrosive. The effects on vehicles and equipment used in snow and ice control are substantial, resulting in mechanical breakdowns, safety hazards, loss of productivity, and high repair and replacement costs.

In recent years the Deep South, most notably Atlanta, Georgia and Charlotte, North Carolina, were hit with unusually severe winter weather. Recognizing that this may be the “new norm,” state departments of transportation (DOTs) and Public Works agencies in that region realize that they must enhance their capabilities to manage snow and ice conditions. This includes expanding fleets by purchase, rental, borrowing from other departments, and retrofitting other units with plows and/or spreaders. These agencies, as well as those in traditional snow country, must consider ways to mitigate the corrosive effects of deicing chemicals.

Even before the recent recession, DOTs and Public Works Departments struggled to acquire adequate funding to replace existing units on a suitable schedule. Replacement budgets were fairly static at best; reduced at worst. Funding to expand fleets to meet operational needs (i.e., maintain Levels of Service in growing areas) was nearly non-existent in most jurisdictions. The result was to keep equipment longer. Extending the service life of a vehicle that operates under harsh conditions can be very costly. In some cases, an agency will spend more on repairs and rehabilitation over a span of several years than it would have cost to purchase a new vehicle outright. Though this is well known by upper management and some elected officials, it still becomes a matter of competing for finite funds. At the municipal level, public works must compete with police and fire for capital funding to buy new vehicles. Typically police and fire receive significant portions of funding they request, while public works are often left short of funding. Nonetheless, executives and elected officials expect a high level of response and performance when winter weather arrives. DOT and local public works managers must do what they can with the resources available and must find ways to keep existing equipment in operable condition. Preventing destructive corrosion is vital to maintaining fleets for the long-term.

Not to be overlooked is the fact that these vehicles and equipment are commonly used throughout the year for other maintenance and construction work, such as pavement and bridge repair, road grading, storm-water drainage systems, traffic control devices and roadway lighting, water and sewage systems, and in some jurisdictions, refuse collection (Milwaukee and New York City are examples of sanitation trucks fitted with snow plows).

This manual presents ideas and innovations that can be readily implemented. The target audience for this manual is line managers responsible for fleet maintenance and/or snow and ice control operations, but can also be used as an information source for vehicle operators and upper management. The manual presents a comprehensive summary of how and why corrosion occurs, the direct and indirect costs of the effects, and practical, feasible ways to prevent and remedy corrosion. The manual will assist in justifying increased funding for initial capital outlay (purchase of vehicles); rehabilitation and upgrade of existing fleets; and better on-going operational practices such as training, selection and use of advanced chemicals, and improved facilities for storage and cleaning of equipment.

Chapter 2: Corrosion Defined – Rust Never Sleeps

Corrosion is described as the deterioration of materials due to the chemical reaction with the environment (Shreir et al., 1994). Corrosion is a natural process caused by the materials' tendency to return to a more natural, stable condition. For example, in humid conditions, iron will rust and return to its original form, iron oxide. The process of corrosion is rapidly increased by the exposure of unprotected metals and alloys to a variety of chemical compounds. For example, zinc can be corroded by dilute sulfuric acid, magnesium by alcohols (NASA-KSC, 1994), and **steel by deicers** (Shi et al., 2013).

Modern vehicles, winter maintenance equipment, and machinery are composed of a wide array of metals such as:

- **Carbon steel** (frames, bumpers, brake lines, body panels, fuel tanks, fittings, exhaust systems, etc.)
- **Cast iron** (engines and drive train components, brake drums and disks, fittings)
- **Aluminum alloys** (body panels, fuel tanks, trim, radiators, wheels, engine and drive train components, fittings)
- **Magnesium alloys** (wheels, transmission housings, brackets and supports)
- **Copper and copper alloys** (electrical wiring, radiators, brake line fittings)

All of these metallic components are subject to the corrosive effects of snow and ice control materials known as deicers (Shi et al., 2013). Corrosion occurs in different forms such as rusting; pitting; galvanic reaction; calcium or other mineral buildup; degradation due to ultraviolet light exposure; and mold, mildew, or other organic decay (US GAO, 2013). There are a variety of corrosion forms which can take place in a vehicle. These types of corrosion can be divided into specific groups.

2.1 General Corrosion

General or uniform corrosion occurs when an exposed surface area of a component deteriorates at the same rate (Shreir, et al., 1994; Roberge, 1999). General corrosion is shown in Figure 1 and is the most common form of corrosion. It is often due to poor material selection for a corrosive medium (Gooch, 2007; NACE GA, 2014).

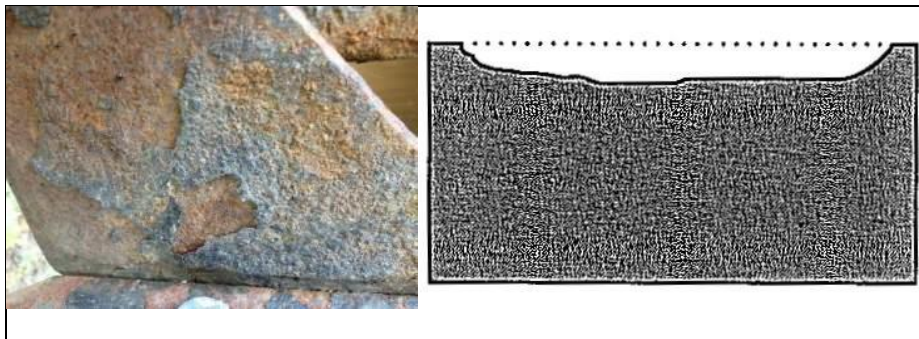

Figure 1. General corrosion (Courtesy of MnDOT and Roberge, 1999).

General corrosion can be reduced by (Gooch, 2007):

- Good material selection
- Use of coatings
- Use of corrosion inhibitors
- Cathodic protection

General corrosion is relatively predictable and can be included in design calculations, such as increasing wall thickness. However, this may not always be feasible for thin-wall components subject to irregular or localized corrosion.

2.2 Localized Corrosion

Localized corrosion occurs on confined areas of a surface whereas the other parts of the surface experience a much lower amount of corrosion. However, most of the exposed surface is subjected to the same corrosion conditions. This can be due to inherent characteristics of the metal, shape of the structure, or the exposure environment. The form of destruction can be shallow to deep holes or cracks with different widths (Shreir, et al., 1994; and Ok, 2006).

Unlike the uniform corrosion, **localized corrosion** is far less predictable (Shreir et al., 1994) and **can cause unexpected failures; therefore, localized corrosion can be more dangerous than general corrosion.** Localized corrosion can be divided into many subclasses such as pitting, stress corrosion cracking (SCC), crevice, erosion, inter-granular, embrittlement, fatigue, galvanic, cosmetic or filiform, and microbially influenced corrosion (MIC) (Libowitz, 1979; Totten, 2001). The following sections summarize the above mentioned forms of localized corrosion.

2.2.1 Pitting Corrosion

Pitting corrosion is a severe form of localized corrosion in which damage in the shape of deep holes occurs (Bosich, 1970). It is often difficult to detect since a relatively small amount of metal is lost (Xi and Xie, 2002). Pits can form close together in clusters (Ayebah, 2006). **Pitting is one of the most destructive forms of corrosion** (Papavinasam, 2014). It is often hard to distinguish pits due to their small diameter, and often times they are concealed (Gadag and Ntyananda Shetty, 2006). Figure 2 **Error! Reference source not found.** shows what pitting corrosion may look like. **Methods that can be used to control pitting corrosion include maintaining clean surfaces, application of a protective coating, and use of inhibitors or cathodic protection for immersion service.** In addition, using steels containing Molybdenum, such as **316 stainless steel**, can reduce pitting corrosion.

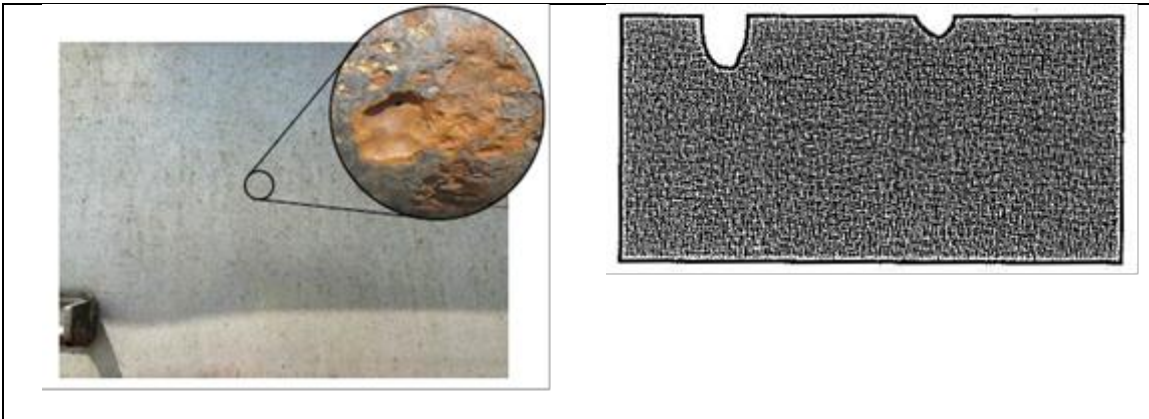

Figure 2. Pitting corrosion (Kopeliovich, 2009; Courtesy of MnDOT and Roberge, 1999).

2.2.2 Crevice corrosion

Crevice corrosion occurs at the interface of a metal and another surface, often where a small volume of stagnant solution can be retained. This is commonly observed beneath surface deposits, lap joints, bolt and rivet heads, seals, gaskets, washers, clamps, sleeves, and similar junctions (Revie, 2011 and Xi and Xie, 2002). Crevice corrosion is often observed on vehicles in narrow gaps, such as the dual frame chassis sections (Mills, 2012). An example of crevice corrosion is shown in Figure 3. (For more information please see Chapter 5: New Equipment Specification – Build to Last).

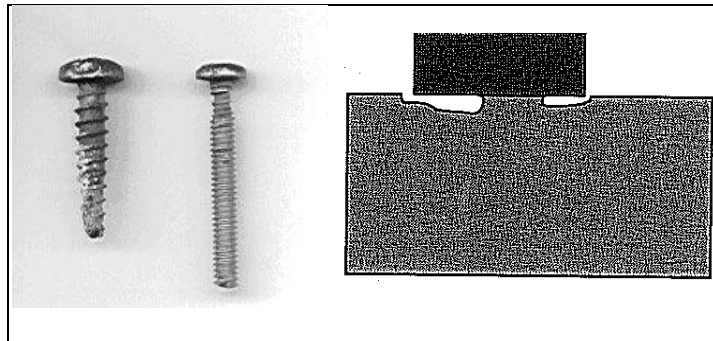

Figure 3. Crevice corrosion (KSC, 2014; Roberge, 1999).

2.2.3 Filiform Corrosion

Filiform corrosion is a special form of crevice corrosion that happens beneath some types of coatings. It is observed in steel, aluminum, and other alloys. Filiform corrosion has a “wormlike” visual appearance as shown in Figure 4 (Rust Bullet, 2014; Roberge, 1999). **“Lacquers and “quick-dry” paints are most susceptible to filiform corrosion.** Their use should be avoided unless absence of an adverse effect has been proven by field experience. Where a coating is required, it should exhibit low water vapor transmission characteristics and excellent adhesion. Zinc-rich coatings should also be considered for coating carbon steel because of their cathodic protection quality” (Rust Bullet, 2014).

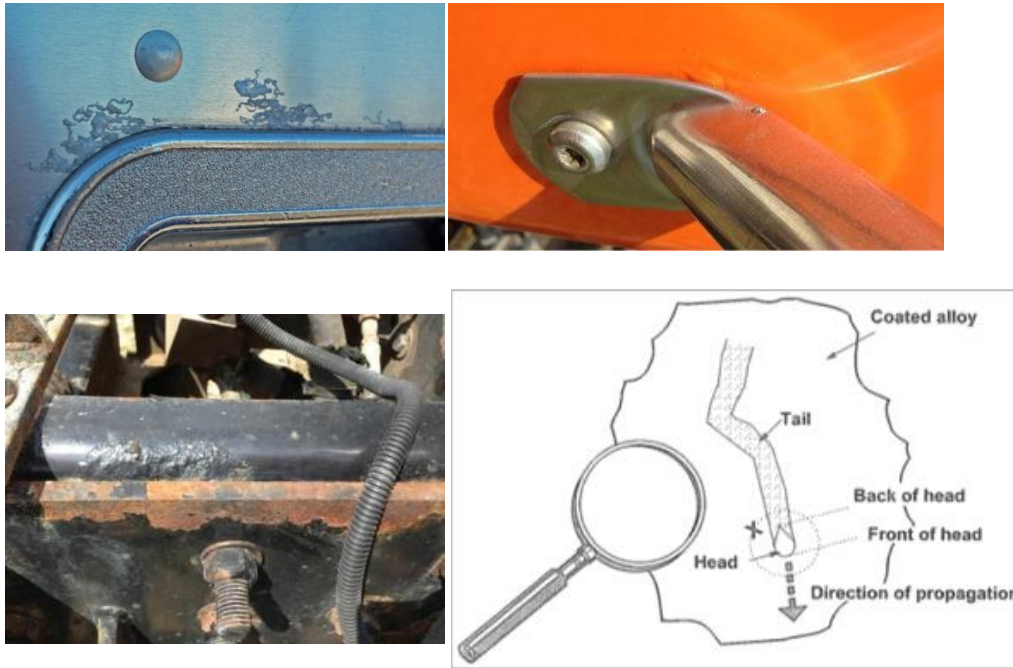

Figure 4. Filiform corrosion (Walkabout Production, 2014; Courtesy of MnDOT and Roberge, 1999).

2.2.4 Intergranular corrosion

Intergranular corrosion occurs at grain boundaries and often spreads along adjacent grain boundaries (Xi and Xie, 2002). Intergranular corrosion is due to impurities present at the grain boundaries, enrichment of an alloying element, or depletion of alloying elements at the grain boundaries. Small amounts of iron in aluminum can move to grain boundaries and cause corrosion damage. The zinc fraction of brass is higher at grain boundaries and makes brass susceptible to intergranular corrosion. In stainless steels, depletion of chromium in the grain boundaries leads to corrosion (Totten, 2001). Intergranular corrosion often **happens in heat affected zones a short distance from the weld** (KSC, 2014), as illustrated in Figure 5.

- Intergranular corrosion can be reduced by using stabilized (321 or 347) or low-carbon (304L or 316L) stainless steels (KSC, 2014).

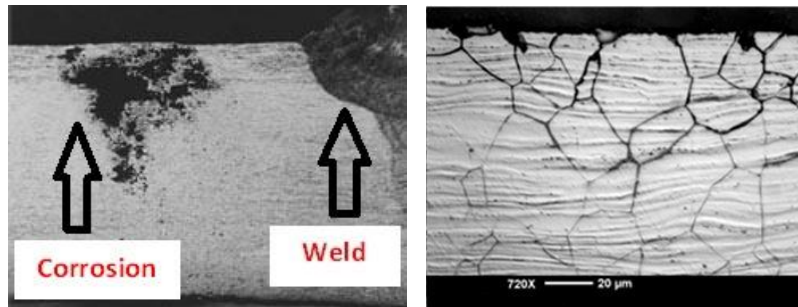

Figure 5. Intergranular corrosion (KSC, 2014, Kopeliovich, 2009 and Roberge, 1999).

2.2.5 Galvanic corrosion

Galvanic or two-metal corrosion occurs when two dissimilar metals are in contact (or are otherwise electrically connected) with each other in the presence of a corrosive electrolyte. Galvanic corrosion occurs when the less resistant metal (reactive, less noble or anodic metal) corrodes at a faster rate than the more resistant metal (passive, more noble or cathodic metal), which corrodes at a slower rate or not at all (Totten, 2001; Xi and Xie, 2002). **Aluminum alloys are susceptible to galvanic corrosion when coupled to steel** (Levelton Consultants, 2008). As shown in Figure 6, a stainless screw used with a cadmium plated steel washer created galvanic corrosion (Rust Bullet, 2014). (For more information please see Chapter 5: New Equipment Specification – Build to Last). Table 1 describes the classification of dissimilar metals.

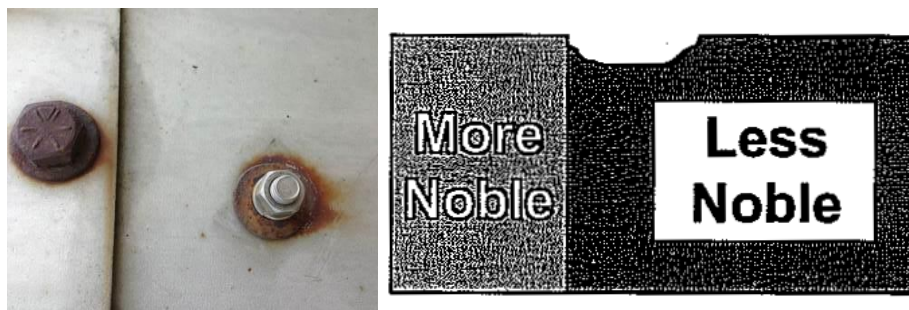
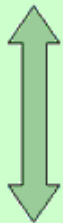

Figure 6. Galvanic corrosion (Courtesy of MnDOT and Roberge, 1999).

Table 1. Classification of dissimilar metals (Boeing, 2014).

Reactive end (anodic)  Passive end (cathodic)	1	Magnesium and magnesium alloys.
	2	Cadmium-titanium plate and cadmium, zinc, aluminum, and their alloys.
	3	Iron, steels (except the corrosion-resistant steels), lead, tin, and their alloys.
	4	Copper, brass, bronze, copper-beryllium, copper-nickel, chromium, nickel and nickel-base alloys, cobalt-base alloys, corrosion-resistant steels (200, 300, 400 series PH steels), graphite, titanium, and titanium alloys.

2.2.6 Stress Corrosion Cracking (SCC)

Damage caused by the interaction of mechanical stress and corrosion is known as **stress corrosion cracking (SCC)** (Xi and Xie, 2002) (Figure 7). The stresses can be due to applied loads, residual stresses caused by manufacturing process, or a combination of both (KSC, 2014). SCC can lead to serious outcomes because it can occur at stresses inside the range of nominal design stress (National Research Council, 1977; NPL, 2000) (For more information please see Chapter 5: New Equipment Specification – Build to Last).

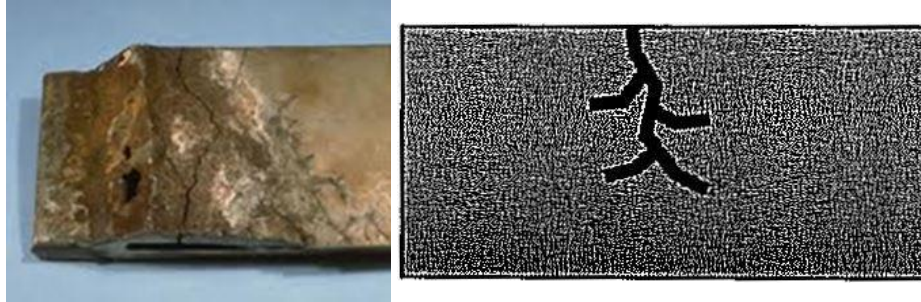

Figure 7. Stress corrosion cracking (Kopeliovich, 2009 and Roberge, 1999).

2.2.7 Corrosion Fatigue

Corrosion fatigue is a kind damage caused by the combined effects of cyclic stress and corrosion (KSC, 2014) (Figure 8 & Figure 9). When a metal is continually exposed to a corrosive media, corrosion fatigue may happen at even lower loads and in a shorter time frame than anticipated (NACE CF, 2014). **Lowering the cyclic stresses and using corrosion control are the best ways to eliminate corrosion fatigue** (KSC, 2014).

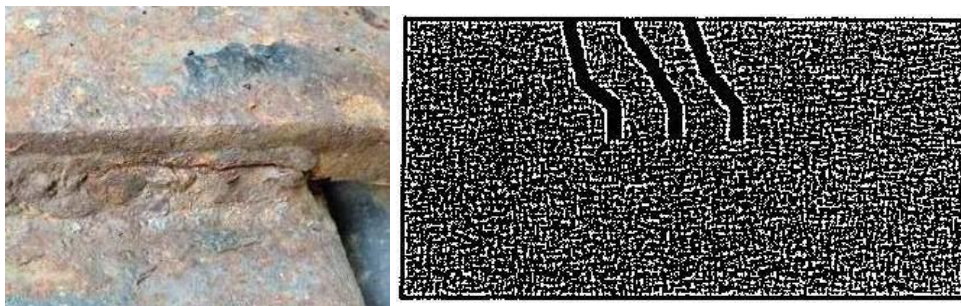

Figure 8. Corrosion fatigue (Courtesy of MnDOT and Roberge, 1999).



Figure 9. An example of corrosion fatigue due to the stresses created by buildup of crevice corrosion products inside the lap joints followed by cyclic loading (KSC, 2014 and Roberge, 1999).

“Rust jacking” is one of the most serious forms of corrosion damage seen in the trucking industry. Rust jacking is “the displacement of building elements due to the expansion of iron and steel products as the metal rusts and becomes iron oxide” (Bucher and Madrid, 1996) (Figure 10). The crevice corrosion creates rust jacking. Once it starts, corrosion will continue spontaneously and may lead to corrosion fatigue. **Rust jacking has been observed when corrosion develops between the brake shoe table and the brake lining.** Rust has a higher volume than the originating mass of iron, and because of this its buildup can force adjacent parts apart. This causes the lining to lift and crack. On a rust-jacked brake shoe, rivets will still be holding part of the lining to the shoe, but inbetween the rivets, it may be cracked. **The most promising approach for prevention of rust-jacking is a process of applying an adhesive membrane between a new shoe table and the lining material.** This heat-activated material melts under the application of the brakes, sealing the lining to the brake shoe. Once the adhesive membrane has set up, that brake shoe cannot be re-lined (Lockridge, 2007). The importance of the brake safety issue is the reason why “DOT and CVSA have stringent inspection standards for brakes including the lining” (OAVET, 2014) (For more information please see Chapter 5: New Equipment Specification – Build to Last).

- Any crack more than 1/16-inches wide and 1-1/2-inches long is cause for inspectors to place a vehicle “out of service” (OAVET, 2014).

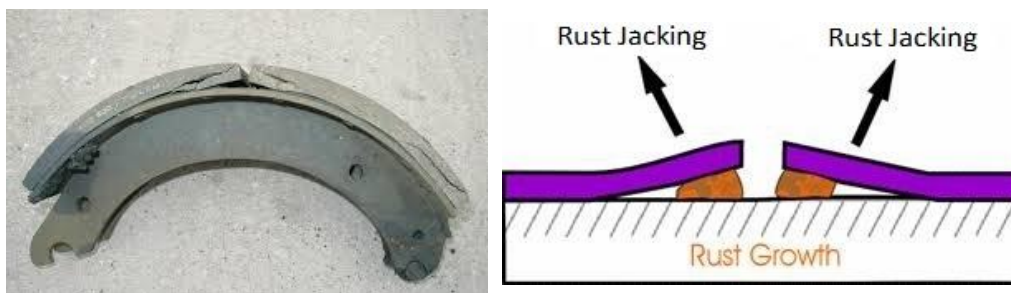

Figure 10. Rust Jacking (Abelson, 2014; Amtec Corrosion and Coatings Consultants, 2014).

2.2.8 Erosion Corrosion

Erosion corrosion is the combination of erosion and corrosion that results in an increased rate at which metal is lost (Xi and Xie, 2002). Erosion corrosion on a metal surface can be in the form of grooves, waves, rounded holes, and/or horseshoe-shaped grooves (Davis, 2001) (Figure 11). Erosion corrosion can be mitigated by design to reduce velocity and turbulence to an extent. Flow-channel dimensions and pumping capacity can be adjusted to minimize capacity. Abrupt changes in flow direction should be avoided, using maximum-radius elbows, and eliminating right-angle T-junctions, when possible, all aid in reducing potential erosion corrosion. Careful welding technique is needed to prevent weld-bead penetration into the flow bath, creating turbulence and increased erosion-corrosion. Valves and pumps themselves should be constructed from resistant material (Shi et al., 2013).

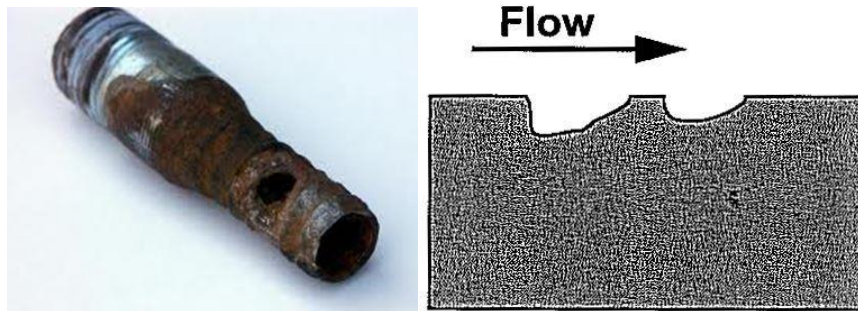

Figure 11. Erosion corrosion (Kopeliovich, 2009; Roberge, 1999).

2.2.9 Fretting Corrosion

Fretting corrosion happens at the interface between contacting, loaded metallic surfaces in the presence of slight vibratory motions (KSC, 2014). Buildup of oxidized debris in pits or grooves can cause fretting corrosion. Fretting corrosion is usually found in machinery, bolted assemblies, ball or roller bearings, and between connectors and terminals in electrical components (Rust Bullet, 2014; GM Techlink, 2014). For example, in electrical connectors, fretting usually appears as: “small, dark smudges on electrical terminals and smudges at the locations of electrical contact” (Figure 12) (GM Techlink, 2014).

- The most effective method for reducing fretting corrosion is cleaning the affected surfaces and applying appropriate lubrication (GM Techlink, 2014).

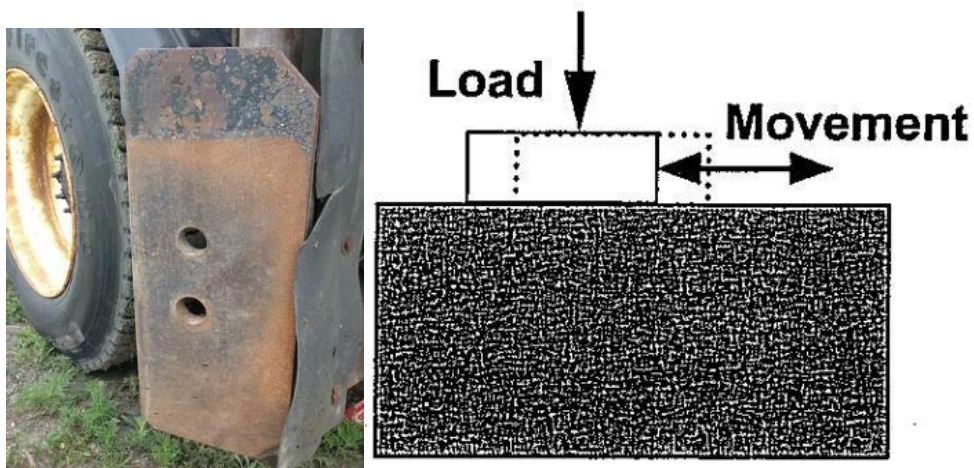

Figure 12. Fretting corrosion (GM Techlink, 2014; Roberge, 1999; and courtesy of MnDOT).

2.2.10 Microbially Influenced Corrosion (MIC)

Microbially influenced corrosion (MIC) refers to a special form of biological corrosion which is directly caused by microorganisms or because of their products (Roberge, 1999; Shi et al., 2003) (Figure 13). Microbially Influenced Corrosion can have significant economic or safety consequences for a wide range of industries if not properly managed. Over the last two to three decades, significant advancements have been made to improve the understanding of dynamic interactions between microbes and metallic surfaces, including the role of biofilm in MIC and associated alternations at the metal/solution interface (Shi et al., 2011).

Microbially influenced corrosion can be a concern for snow and ice control equipment when agencies use bio-based products, especially beet sugar refining by-products, for preparing deicers. Monty et al. (2014) mentioned the plow as one the most susceptible parts in winter maintenance equipment to this kind of corrosion. Generally MIC can occur on any component that contacts with bio-based deicers. There is now a growing amount of information related to the mitigation of MIC, including technological advances in identifying microbes and detecting and characterizing MIC; chemical or biological approaches to sterilize the system (e.g., with fumigants, biocides, or biophages) or removal of biofilms to inhibit the growth and/or metabolism of corrosion-related microbes, and to prevent or reduce the formation of biofilms; surface treatments (anti-microbial or antifouling coatings and super hydrophobic surfaces); and beneficial uses of live biofilms or microbial EPS (Shi et al., 2011).

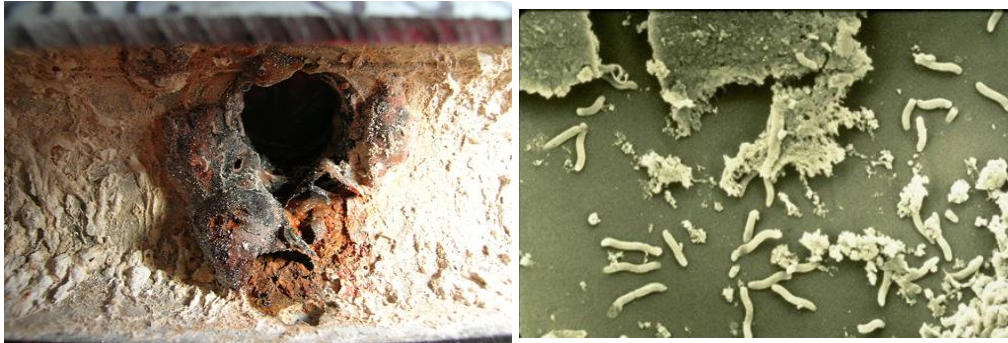

Figure 13. Microbially influenced corrosion (MIC) (BTI, 2014).

Chapter 3: Causes and Effects of Corrosion

The varying properties of different metals determine the means through which they corrode. Understanding the manner in which corrosion takes place can be used to determine the best metal for a given application and how to protect each metal type from corrosion through the use of coatings, inhibitors, and design. **The conditions metals are exposed to, such as temperature, chloride or sulfur level, precipitation, or time of wetness play a significant role in the amount of corrosion and the manner in which the corrosion occurs.**

An increase in temperature at constant relative humidity causes an increased corrosion rate. However, when temperature is increased and the relative humidity generally decreases, evaporation will occur and a decreased time of wetness. The time of wetness of the metal surface is closely related to the length of time the corrosion reactions take place. The longer the time of wetness, the greater the length of time the corrosion has to take place. Temperature, relative humidity, and time of wetness are closely related to the corrosion process. Moreover, precipitation also affects corrosion and time of wetness. Along with increasing the time of wetness, precipitation can affect the chloride/pollutant levels (sometimes adding to these levels but other times washing away these deposits).

According to a recent U.S. National Cooperative Highway Research Program (NCHRP) report, crevice corrosion and poulitice corrosion typically occur where dirt and moisture are trapped – between adjacent pieces of metal, under gaskets and at fasteners, or on the surface of motor vehicle components (Levelton Consultant, 2008). Poulitice corrosion occurs under or around a discontinuous deposit on a metallic surface (Engineering Dictionary, 2014). This is compounded by ingress of snow and ice control chemicals and other ionic materials (e.g., acid rain) that increase the conductivity of the trapped moisture. **Aluminum alloys are more prone to crevice corrosion and galvanic corrosion when coupled to steel** (Levelton Consultant, 2008).

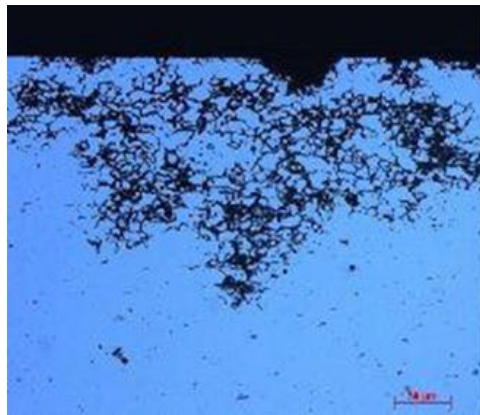

Figure 14. Selective attack of grain boundary on aluminum exposed to chloride-based deicers (Stephens, 2006).

In a case study conducted by the Western Transportation Institute (WTI), researchers investigated the corrosion of trucks exposed to deicers applied on Montana highways and observed significant crevice corrosion between the conjunction of the winch frame and the truck frame, in conjunctions on the truck

frame, and as filiform corrosion under the coating near frame corners and on brake chambers. Other forms of less significant corrosion on the trucks, such as pitting corrosion on the outer surfaces of stainless steel parts and aluminum fuel tanks, galvanic corrosion, and SCC in the welding zones or conjunction of dissimilar metals, were also observed (WTI, 2005).

3.1. Corrosion-prone parts on DOT equipment

Sites likely to exhibit corrosion are areas where dirt and other material deposit and remain wet, including metal folds and joints, breaks in painted surfaces, threaded-screws, and beneath coatings that do not adhere well to the surface beneath (Baldi et al., 1989). The structural components of the underbody are normally composed of low carbon steel and high strength steel. **These underbody components commonly experience pitting, crevice, galvanic, and cosmetic corrosion.** Pitting corrosion is a localized attack, often caused by chlorides, which results in a rough surface. Crevice corrosion occurs when an electrolyte is trapped in joints, crevices, poutices, or under deposits. Galvanic corrosion occurs where different types of metals come in contact with one another. Cosmetic corrosion often originates where the coating or paint is damaged or penetrated. The damage to the surface is usually just visual but in some cases may be more severe (Light Truck, 1999). Figure 15 shows the allocation of corrosion related repair cost incurred on Washington State Department of Transportation (WSDOT) equipment.

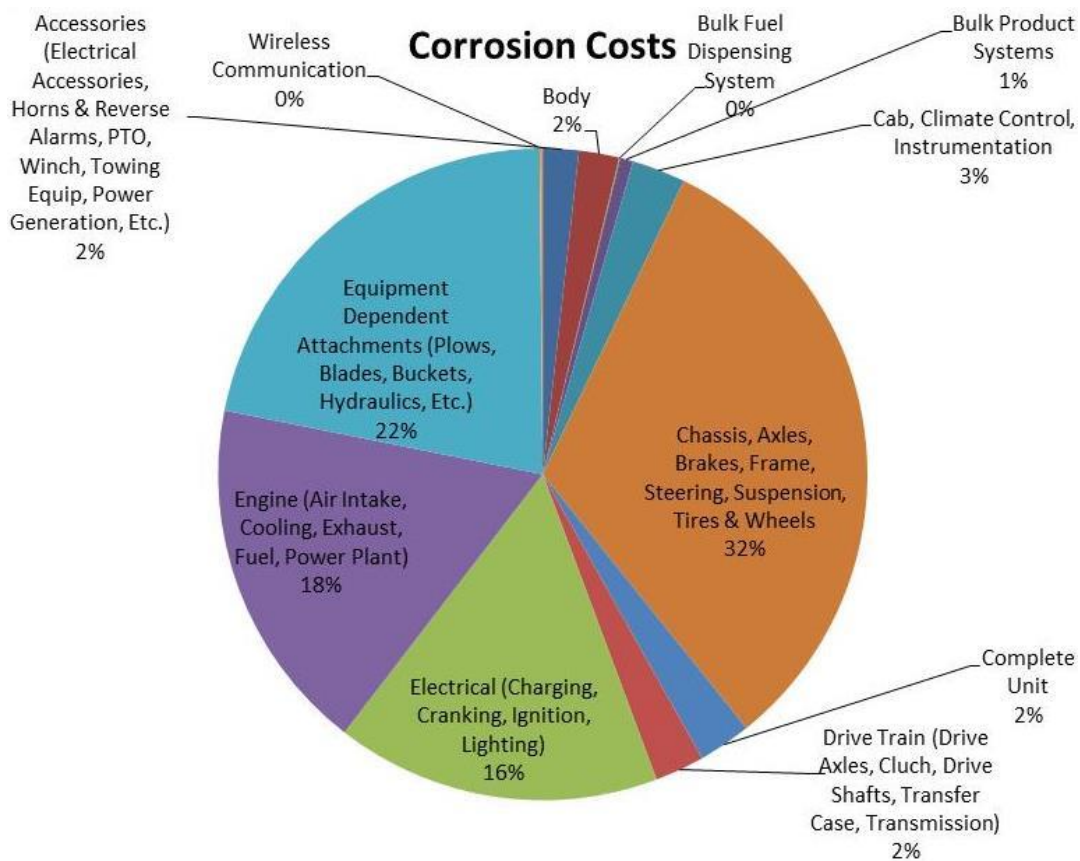

Figure 15. Allocation of corrosion-related repair costs among WSDOT equipment (Shi et al., 2014).

In recent years there has been a rise in concern about the integrity of the semi-truck components that are prone to corrosion (Hartley, 2010). For example, five of the major vehicle manufacturers have recalled about 7.4 million vehicles in the last few years due to premature corrosion of vehicle safety components caused by deicers, including: brake line malfunctioning, deterioration of the axle, steering issues, and problems with the gas tank (Cornwell, 2011). The same problems occur with dump trucks and other vehicles used for roadway snow and ice control. **Figure 16 – Figure 19 show various causes and effects of corrosion on equipment.** As shown in Figure 16, chloride based deicers can cause pitting corrosion on the metallic parts of truck (For more information please see sections 2.2.1 Pitting Corrosion and 5.1. Metal Materials Selection).

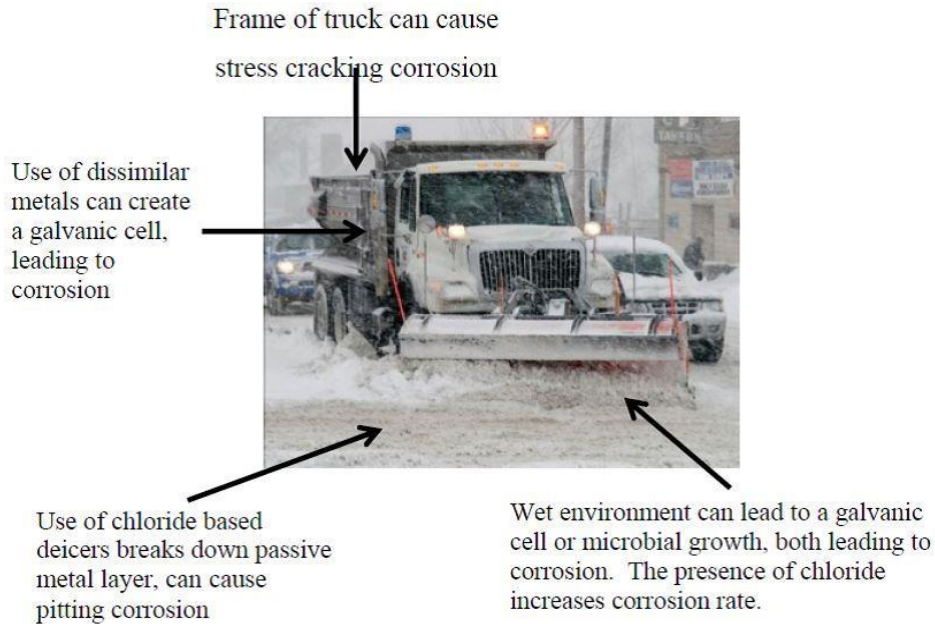

Figure 16. Corrosion on snow and ice equipment (Monty et al., 2014).



Figure 17. Images of salt-related damage on brake drum and exhaust system (Shi, 2014).



Figure 18. Image of salt-related vehicle damage (Mills, 2011 and 2012).



Figure 19. Images of corrosion damages on PennDOT vehicles (Smith, 2014).

3.2. Effect of Deicers on Metals, Infrastructure and Environment

Large amounts of solid and liquid chemical deicers, as well as abrasives, are applied onto winter highways to keep them clear of ice and snow. Deicers applied onto highways often contain chlorides because of their cost-effectiveness, including mainly sodium chloride (NaCl), magnesium chloride (MgCl_2), and calcium chloride (CaCl_2), sometimes blended with proprietary corrosion inhibitors. A recent survey of highway maintenance agencies indicated that **NaCl was the most frequently used deicer, followed by abrasives, then MgCl_2 , agriculturally based products, CaCl_2 , and others.** Less

than 25% of the survey respondents used alternative deicers such as potassium acetate (KAc), sodium acetate (NaAc), calcium magnesium acetate (CMA), and potassium formate (Fay, et al. 2008). Additional information on these products can be found in Chapter 4: Materials Used for Snow and Ice Control. **Figure 20 – Figure 27 illustrate corrosion effects on various components of snow and ice control equipment used in routine winter maintenance operations.**

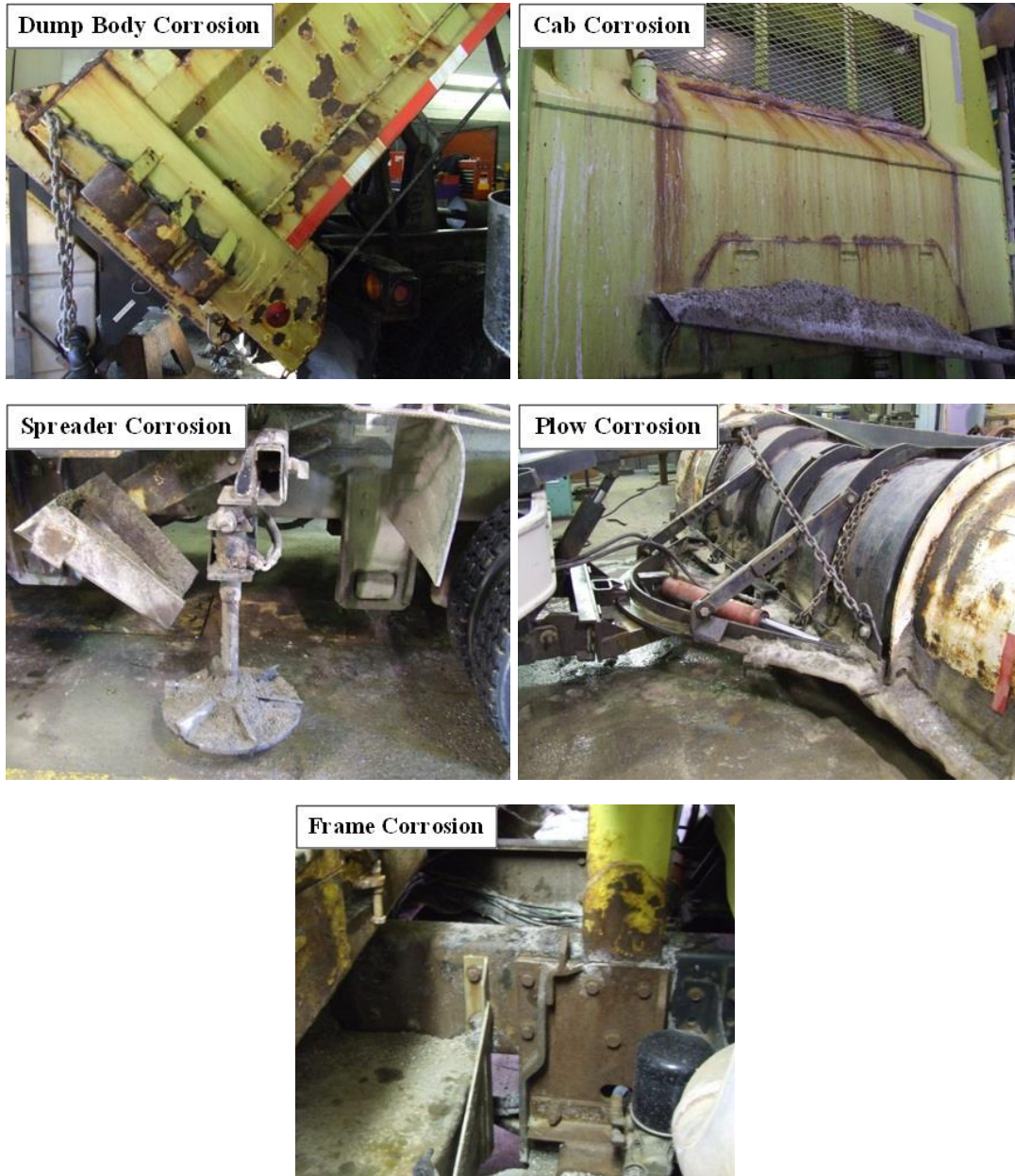

Figure 20. Images of vehicle corrosion damage taken by PRP Industries (PRP, 2014).



Figure 21. Images of corrosion damage on (Michigan DOT vehicles courtesy of MDOT).

In 2007 the U.S. sold approximately 20.2 million tons of deicing salts for use in winter maintenance (Salt Institute, 2008). The **growing use of deicers has raised concerns over their effects on motor vehicles, transportation infrastructure, and the environment** (Buckler and Granato, 2002; FHWA, 2002; Johnson, 2002; Amrhein, 1992). Motorists and trucking associations have become wary of deicers on their vehicles, as the vehicular corrosion (even though generally cosmetic) continues to be documented. **On average, deicer corrosion has been estimated to cost \$32 per vehicle per year** (Johnson, 2002). **Investing in washing equipment and corrosion inhibitors is a cost effective method to reduce impacts of corrosion** (Shi et al., 2013). When using chloride-based deicers for snow and ice control, the average cost due to corrosion and environmental effects are estimated at three times as high as the

nominal cost (Shi, 2005). One study has estimated that the use of road salts imposes vehicular corrosion costs of at least \$113 per ton, aesthetic costs of \$75 per ton if applied near environmentally sensitive areas, in addition to uncertain human health costs (Vitaliano, 1992).

Parking garages, pavements, roadside infrastructure, and non-highway objects near winter maintenance activities are also exposed to the corrosive effects of road salts. It should be noted that any repairs to the infrastructure translate to costs to the user in terms of construction costs, traffic delays and lost productivity (Thompson et al., 2007).

- **Indirect costs due to corrosion are estimated to be greater than ten times the cost of corrosion maintenance, repair, and rehabilitation** (Thompson et al., 2007).



Figure 22. Images of corrosion damage on NYSDOT vehicles (courtesy of NYSDOT).

3.3. Common Deicers exposed to vehicles and equipment

A survey completed by Shi et al. (2013) sought feedback on the types of deicers to which vehicles and equipment were exposed. The following four deicers; salt, pre-wetted salt, sand/salt blend and sodium chloride brine, were listed as “frequently or very frequently exposed” to vehicles/equipment in this survey. It is interesting to note that **only 12.6% of the survey respondents used non-chloride deicers, likely due to fact that chloride deicers are easily available, relatively inexpensive, or easier to use for winter maintenance than non-chloride deicers, despite their higher risk to vehicles and equipment.** The survey respondents also indicated that in areas with cold-temperature, the **use of**

corrosion-inhibited magnesium chloride (vs. the non-inhibited chloride brines) to pre-wet sand **could lead to reduced corrosion risk** to vehicles and equipment (Shi, et al., 2013).



Figure 23. Images of corrosion damages on NDDOT vehicles (courtesy of NDDOT).

3.4. Annual expenditures to manage deicer corrosion of vehicles/equipment

The survey by Shi et al. (2013) also identified annual expenditures for managing deicer-related metallic corrosion by agencies that report it as being a significant issue.

The average estimated annual costs per agency for corrosion management in six areas are as follows:

- **Training programs (\$190,938)**
- **Materials selection (\$320,667)**

- Design improvements (\$45,000)
- Corrosion monitoring and testing (\$10,000)
- Proactive maintenance (\$171,424)
- Reactive maintenance (\$325,000)



Figure 24. Images of corrosion damages on RIDOT vehicles (courtesy of RIDOT).

While there were some responses from cities and counties, most responses came from state DOTs. In addition, it is assumed that the average cost numbers reported reflect the current practice by an “average agency” (e.g., a northern state DOT with an average size of fleet assets). Based on the values presented, the total cost of corrosion management related to deicer exposure is estimated to be \$1,063,029 per year, which is equal to 0.6% of the equipment assets for an agency such as WSDOT (Shi et al., 2013).



Figure 25. Images of corrosion damages on VAOT vehicles (courtesy of VAOT).

3.5. Risks of Deicer Corrosion to the Equipment Fleet

The agency survey by Shi et al. (2013) also identified the current risks of deicer corrosion to the equipment fleet of responding agencies that report it as being a significant issue, estimated under the current level of corrosion management (Table 2). As such, the total cost of current corrosion risks related to deicer exposure is estimated to be \$14,050,368 per year.

Table 2. Estimated risk of equipment corrosion due to deicer exposure alone and annual costs of estimated equipment corrosion risks due to deicer exposure (Shi et al., 2013).

	Depreciation in equipment value	Increased equipment downtime	Reduced equipment reliability	Reduced equipment service life	Increased premature repair and replacement	Safety risk due to faulty parts on equipment
Estimated risks	17.3%	8.5%	11.9%	17.3%	19.6%	1.5%
Annual costs	\$12,512,227	\$69,167	\$172,000	\$1,127,750	\$118,823	\$30,000

According to Table 2, deicer exposure leads to risks in six areas as an average of:

- **17.3% depreciation in equipment value**
- **8.5% in increased equipment downtime**
- **11.9% in reduced equipment reliability**
- **17.3% in reduced equipment service life**
- **19.6% in increased premature repair and replacement**
- **1.5% reduced safety, due to faulty parts on equipment**



Figure 26. Images of damages due to corrosion on VAOT vehicles (courtesy of VAOT).

3.6. Metallic Corrosion on Types of Equipment and Components

In a survey conducted by Shi et al. (2013) survey respondents were asked to rank the risk of metallic corrosion to the types of equipment the respondents' agency owns

Table 3). Dump trucks were most often cited as having “very high” risk of metallic corrosion (49%), followed by liquid deicer application equipment (34%). Survey respondents were also asked to rank the risk of chloride deicers to various components of their agency’s vehicles/equipment (Table 4). The average ranking of risk of corrosion from deicers by survey respondents was greatest for electrical wiring (4.5), followed by Frames (4.0), Brackets and supports (3.9), Brake air cans (3.9), Fittings (3.9), and Spreader chute (3.9). Liquid storage tanks have the lowest perceived risk of deicer corrosion (2.8).

Table 3. Ranking the risk of metallic corrosion to the types of equipment the respondents' agency owns (Shi et al., 2013).

Equipment listed	Not Applicable (%(n))	Very Low (%(n))	Low (%(n))	Moderate (%(n))	High (%(n))	Very High (%(n))	Average No. of severity (%(n))
Dump trucks	6.4% (3)	4.3% (2)	4.3% (2)	14.9% (7)	21.3% (10)	48.9% (23)	4.1 (47)
Liquid deicer applicators	2.3% (1)	4.5% (2)	13.6% (6)	25.0% (11)	20.5% (9)	34.1% (15)	3.7 (44)
Hoppers	7.0% (3)	7.0% (3)	9.3% (4)	27.9% (12)	23.3% (10)	25.6% (11)	3.6 (43)
Front end loaders	4.5% (2)	4.5% (2)	15.9% (7)	25.0% (11)	25.0% (11)	25.0% (11)	3.5 (44)
Supervisor trucks or crew pickups	2.1% (1)	6.4% (3)	25.5% (12)	36.1% (17)	23.4% (11)	6.4% (3)	3.0 (47)
Graders	17.8% (8)	15.6% (7)	24.4% (11)	28.9% (13)	8.9% (4)	4.4% (2)	2.5 (45)



Figure 27. Images of corrosion damages on ConnDOT vehicles (Chupas, 2014).

Table 4. Ranking the risk of chloride deicers to various components of the agency's vehicles/equipment (Shi et al., 2013).

Components	Very low (%(n))	Low (%(n))	Moderate (%(n))	High (%(n))	Very High (%(n))	Average No. of severity (%(n))
Brackets and supports	2.5% (1)	2.5% (1)	27.5% (11)	32.5% (13)	32.5% (13)	3.9 (40)
Brake drums and disks	5.0% (2)	7.5% (3)	20.0% (8)	35.0% (14)	30.0% (12)	3.8 (40)
Brake air cans	2.5% (1)	7.5% (3)	20.0% (8)	32.5% (13)	35.0% (14)	3.9 (40)
Brake lines	7.5% (3)	15.0% (6)	17.5% (7)	30.0% (12)	25.0% (10)	3.5 (40)
Bumpers	5.0% (2)	17.5% (7)	37.5% (15)	22.5% (9)	12.5% (5)	3.2 (40)
Body panels	2.5% (1)	7.5% (3)	37.5% (15)	35.0% (14)	17.5% (7)	3.6 (40)
Electrical wiring	0.0% (0)	0.0% (0)	7.5% (3)	40.0% (16)	52.5% (21)	4.5 (40)
Engines and drive train components	2.5% (1)	10.0% (4)	47.5% (19)	22.5% (9)	17.5% (7)	3.4 (40)
Exhaust systems/Mufflers	2.5% (1)	2.5% (1)	42.5% (17)	32.5% (13)	17.5% (7)	3.6 (40)
Fittings	0.0% (0)	5.0% (2)	27.5% (11)	35.0% (14)	30.0% (12)	3.9 (40)
Frames	2.5% (1)	0.0% (0)	20.0% (8)	47.5% (19)	27.5% (11)	4.0 (40)
Fuel tanks	0.0% (0)	12.5% (5)	35.0% (14)	35.0% (14)	17.5% (7)	3.6 (40)
Radiators	0.0% (0)	10.0% (4)	50.0% (20)	20.0% (8)	17.5% (7)	3.5 (40)
Transmission housings	5.0% (2)	22.5% (9)	30.0% (12)	25.0% (10)	15.0% (6)	3.2 (40)
Trim	5.1% (2)	23.1% (9)	41.0% (16)	15.4% (6)	10.3% (4)	3.0 (39)
Wheels	5.1% (2)	12.8% (5)	15.4% (6)	43.6% (17)	20.5% (8)	3.6 (39)
Granular hopper	19.4% (7)	5.6% (2)	2.8% (1)	30.6% (11)	36.1% (13)	3.6 (36)
Spreader auger	8.1% (3)	16.2% (6)	10.8% (4)	24.3% (9)	37.8% (14)	3.7 (37)
Spreader chute	5.3% (2)	10.5% (4)	7.9% (3)	31.6% (12)	39.5% (15)	3.9 (38)
Spreader disc	18.4% (7)	15.8% (6)	10.5% (4)	21.1% (8)	26.3% (10)	3.2 (38)
Spray bar	15.8% (6)	15.8% (6)	5.3% (2)	31.6% (12)	23.7% (9)	3.3 (38)
Liquid storage tanks	28.9% (11)	18.4% (7)	13.2% (5)	13.2% (5)	21.1% (8)	2.8 (38)
Plow blades/cutting edges	13.2% (5)	23.7% (9)	15.8% (6)	23.7% (9)	18.4% (7)	3.1 (38)
Hydraulic systems/pumps/ hoses/cylinders/valves	5.3% (2)	7.9% (3)	21.1% (8)	36.8% (14)	26.3% (10)	3.7 (38)

3.7. Common Types of Corrosion-Prone Material and their Respective Forms of Corrosion

Shi et al. (2013) asked survey respondents about corrosion-prone material seen in their agency's equipment fleet. As presented in Table 5, cast irons have the most serious general or uniform corrosion (81.3%) followed by carbon steels (73.5%), composites (68.8%) and magnesium alloys (68.2%). On the other hand, aluminum alloys and stainless steels have the most serious localized corrosion (50%) followed by metallic glass (43.8%), metallic coatings (40.0%) and magnesium alloys (36.4%). WSDOT began tracking corrosion costs associated with deicer usage and equipment asset data in 2008. For the entire WSDOT fleet, the corrosion-related repair costs and PM costs averaged 4.3% and 12.9% of the total repair costs (excluding PM costs), respectively (Shi, et al., 2013). For the WSDOT snowplows, the corrosion-related repair costs and PM costs averaged 9.3% and 10.1% of the total repair costs (excluding PM costs), respectively.

Table 5. Common types of corrosion-prone material and their respective forms of corrosion seen in vehicles/equipment exposed to chloride deicers (Shi et al., 2013).

Materials	General or uniform corrosion %(n)	Localized corrosion %(n)	Number of Responses (n)*
Cast irons	81.3% (26)	21.9% (7)	32
Aluminum alloys	55.9% (19)	50.0% (17)	34
Magnesium alloys	68.2% (15)	36.4% (8)	22
Copper and copper alloys	67.9% (19)	35.7% (10)	28
Carbon steels	73.5% (25)	32.4% (11)	34
Stainless steels	50.0% (12)	50.0% (12)	24
Metallic coatings	64.0% (16)	40.0% (10)	25
Metallic glass	56.3% (9)	43.8% (7)	16
Composites	68.8% (23)	31.3% (5)	28

* Some respondents selected both forms of corrosion.

3.8. Cost-Benefit Analysis of Mitigating Deicer Corrosion to DOT Equipment

For an average agency, it is assumed that the empirical 20/80 rule may apply to the 25% of corrosion costs which can be avoided by best practices, in the absence of actual data being available. In other words, it should be possible to reduce the current cost of corrosion risk related to deicer exposure by 80% × 25%, if the agency can increase its current investment in equipment corrosion control by 20%. This is possible by conducting risk analysis to identify the critical 20% of corrosion-related failures and focusing more on training and risk-based maintenance (Shi et al., 2015). In other words, efforts should be focused on efficient investment in corrosion cost avoidance. Improved staff training, preventive maintenance of

DOT equipment, and other best practices (e.g., improved monitoring and inspection) are expected to lead to substantial cost reduction. Based on the data from the averaged survey responses, the benefit/cost ratio of further mitigating corrosion from deicers to DOT fleet equipment can be estimated as follows: $(80\% \times 25\% \times \$14,050,368) / (20\% \times \$1,063,029) = 13.2$. This ratio is conservative because it does not take into account the indirect costs of equipment corrosion, which could be significantly higher than the direct costs (Shi et al., 2015).

3.9. Supplemental Information

3.9.1 Chloride Deicer Corrosion Problem

Chloride deicers pose a significant risk to vehicles and equipment; causing very high metallic corrosion rates to dump trucks, liquid deicer applicators, and front end loaders; and causing moderate metallic corrosion to hoppers, supervisor vehicles or crew pickups and graders (Shi, et al., 2013).

The numbers of vehicles and the amount of equipment at risk of metallic corrosion is colossal and the cost to maintain them is overwhelming agencies.

Annual costs to maintain vehicles from the survey by Shi et al. (2013) include:

- **515 pieces of equipment need \$50 million (\$97,097 per vehicle) to maintain;**
- **3,000 units need \$125 million (\$41,666 per vehicle) to maintain;**
- **80 units need \$11.6 million (\$145,000 per vehicle) to maintain.**

Other expenses caused by deicer related corrosion such as vehicles/equipment depreciation in value, vehicles/equipment downtime, reduction in vehicle reliability, and reduced safety of operators and others due to faulty components, were also shown to be significant (Shi, et al., 2013).

3.9.2 Chloride Deicer Corrosion Causes

Four materials were listed as “very frequently exposed” to vehicles in this survey by Shi et al. (2013): salt, pre-wetted salt, sand/salt blend and sodium chloride brine. An interesting finding of the survey was that the amount of deicers exposed to the agencies’ vehicles/equipment on an annual basis was more than expected:

- 443,000 tons of salt per year.
- 684,000 gallons of liquid calcium chloride per year.
- 112,000 gallons of liquid magnesium chloride per year.

In the survey by Shi et al. (2013), corrosion to several specific vehicles/equipment components was associated with exposure to chloride deicers. Key results include:

- 32.5% of respondents agree bracket and supports have a very high risk of corrosion caused by chloride deicers,

- 35% of respondents agree brake drums and disks have a relatively high of corrosion caused by chloride deicers, and
- 52.5% of respondents agree that electrical wiring has a high risk of corrosion caused by chloride deicers.

The susceptibility of the different types of materials used in vehicles to corrosion is worth noting:

- Cast irons have an 81.3% risk of corrosion from chloride deicers,
- Aluminum alloys have 55.9% risk of corrosion from chloride deicers,
- Magnesium alloys have 68.2% risk of corrosion from chloride deicers,
- Carbon steels have 73.5% risk of corrosion from chloride deicers, etc.

Appendix B: Test Methods and Online Monitoring Techniques for Anti-Corrosion Practices provides an up to date summary of corrosion test methods and equipment.

Chapter 4: Materials Used for Snow and Ice Control

The most commonly used materials for snow and ice operations are rock salt and sand. This has been the standard for decades because both materials are effective, relatively inexpensive, and readily available. In fact, for many years agencies tended to use only sand, thus the term “sanders” is often used to describe trucks capable of spreading materials on pavement. Liquid salt brine, magnesium and calcium chloride are also used either mixed with sand and salt or sprayed directly on pavement. In recent decades, a number of other chemicals, some that are agricultural by-products, have been developed for anti-icing and de-icing. Table 6 shows deicers used by respondents of a survey conducted by Fay et al. (2008).

Table 6. Deicer listed by survey respondents as being used by their organization, showing frequency of use (Fay et al., 2008).

De/Anti-icers Listed	Abbreviation	Frequency (n)	Percent of Respondents (%)
Abrasives (sand)	sand	17	71
Sodium Chloride (solid)	NaCl (s)	20	83
Sodium Chloride (liquid brine)	NaCl (l)	4*	17
Sodium Chloride & Abrasives	NaCl & sand	3*	13
Magnesium Chloride	MgCl ₂	14	58
Calcium Chloride	CaCl ₂	11	46
Clearlane®	NaCl, MgCl ₂	3	13
IceSlicer®	NaCl, KCl, Mg Cl ₂	3	13
Calcium Magnesium Acetate	CMA	2	8
Potassium Acetate	K-acetate	6	25
Sodium Acetate	Na-acetate	2	8
Potassium Formate	K-formate	1	4
Agricultural Based	Ag-based	12 [†]	50

* Only counted if specified use in survey.

† Ag based deicers included: Ice B'Gone® (n=2), Magic by Caliber® (n=1), beet and/or corn based (n=3), unspecified Ag-based as inhibitor mixed with MgCl₂ (n=2), unspecified Ag-based as inhibitor mixed with CaCl₂ and NaCl(l) (n=1), or an unspecified small amount of Ag-based listed generally as inhibitor (n=3), and Geomelt® (n=1).

Generally, the materials used for snow and ice control are either chemically inert or active. Inert materials have no de-icing properties; they simply provide temporary traction on icy pavement. Sand, finely crushed “rock dust,” pumice, cinders and slag from coal-fired power plants or foundries, sawdust, even crushed oyster shells in coastal areas have been used. Sand is often mixed with rock salt and/or liquid brine (NaCl), magnesium chloride (MgCl₂) or calcium chloride (CaCl₂). The added solid and liquid salts provide the de-icing action that the public mistakenly thinks that the sand alone is producing. Sand and other inert materials only provide traction enhancement, which is temporary as the material tends to get crushed, after which it bounces and scatters off the road surface by vehicle traffic. Once the snow and ice have melted off, the sand or cinder fine particles can build up on the side of the road or become air

pollutants. Additionally, inert material residue must be swept off the pavement before it washes into storm-water drainage systems, or adjacent waterways.

Chemically active de-icing materials are:

- Sodium chloride – either as solid rock salt or in solution as brine; not effective below 15-20°F degrees. Sodium chloride is corrosive especially on steel components and under immersion and in arid environments (Mills, 2012).
- Calcium Chloride – either as solid or liquid; works at colder temperatures than sodium chloride and is very corrosive especially for aluminum parts (Xi and Xie, 2002).
- Magnesium Chloride – either as solid or liquid; works at colder temperatures than sodium chlorides, but not at temperatures as cold as calcium chloride works. Magnesium chloride affects aluminum, and is more corrosive than sodium chloride under humid conditions (Mills, 2012).
- Potassium Acetate
- Calcium Magnesium Acetate
- Sodium Acetate
- Potassium Formate

In the last two decades, acetate-based deicers such as potassium acetate (KAc), sodium acetate (NaAc) and calcium magnesium acetate (CMA) have gradually replaced urea as a freezing-point depressant and are used by some transportation agencies to treat winter roadways. In addition, formates such as sodium formate (NaFm) and potassium formate (KFm), as well as bio-based products have emerged as potential alternative deicers (Fay and Shi, 2012).

Chapter 5: New Equipment Specification – Build to Last

This chapter discusses some of the proactive approaches to corrosion prevention and material selection, including the methods and knowledge obtained from past experience and design improvements. As discussed before, different metals have various characteristics and the corrosion types associated with these metals greatly vary. Certain metals are more susceptible to corrosion, which makes choosing materials for desired designs an essential component of corrosion protection. Subsequently, information is presented on how to improve and maintain designs that will assist in the prevention of equipment corrosion.

Is It Worth The Cost?

Of course, many of these design and construction recommendations may add to the overall cost of purchasing a new vehicle, in the range of 10-20% over an agency's current specifications. However, this increase in capital equipment outlay is justified by the long-term reduction in maintenance (repair, replacement, and reconditioning) due to corrosion. Consider also the extended useful life of the vehicles and the decrease in unnecessary down-time during periods (such as snow storms) when they are needed in-service. Fleet Superintendents and Operations Managers need to emphasize these points in budget requests. A "show-and-tell" with the key budget decision makers may be a useful tool so that they see first-hand the deterioration caused by corrosion and how it affects the fleet both financially and operationally.

5.1. Metal Materials Selection

In past decades, countless amounts of time and effort have been dedicated to anti-corrosion research. Advancements in technology have allowed for various improvements in material selection to minimize corrosion. Furthermore, results from anti-corrosion material research laboratories and other resources are constantly being evaluated in order to find the best materials for use in corrosive environments.

Figure 28 shows an investigation of how resistant each material is to corrosion in exhaust systems exposed to de-icing salts. Aluminized mild steel was found to be the most resistant alloy against pitting (Oliver, 2003). Aluminum is one of the most widely used metals, next to steel. In natural environments unalloyed aluminum has superior corrosion resistance properties than carbon steel but has poor mechanical strength. Metallurgists and corrosion engineers are trying to improve the mechanical performance of aluminum without losing the corrosion resistance properties. In general, magnesium alloys and mill product forms of aluminum alloys 2020, 7079, and 7178 should not be used for structural applications. The use of 7xxx-T6 Al alloys should be limited to a thickness of no more than 0.080 inches (CPC, 2007).

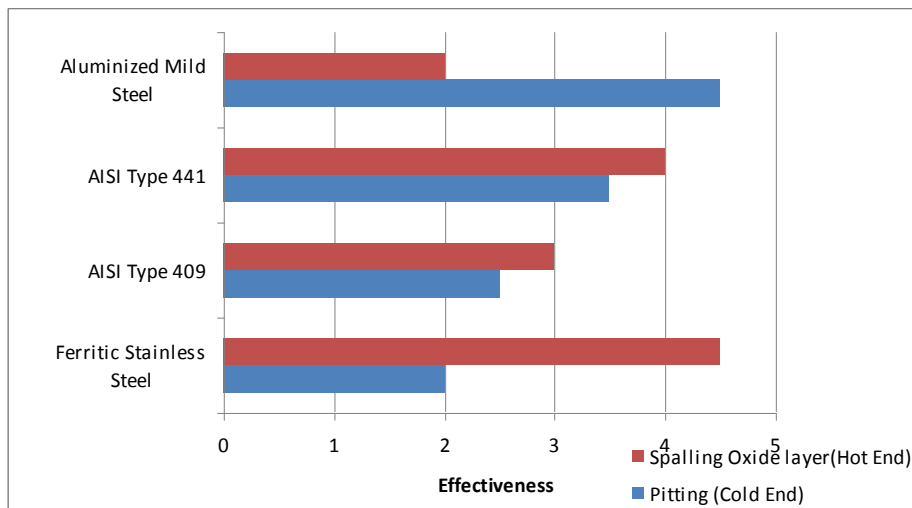

Figure 28. A study of exhaust systems exposed to de-icing salts (Oliver, 2003).

In natural environments, unalloyed aluminum has superior corrosion resistance properties relative to carbon steel but poor mechanical strength. If a high-strength alloy is needed, it is recommended to use exfoliation resistant tempers such as T76 or 7xxx alloys with copper. Copper-free alloys and alloys with low noble impurities, or alloying elements in general, feature high resistance to pitting corrosion. Aluminum alloys in the 1xxx, 2xxx, 3xxx, 5xxx, and 6xxx series have high corrosion resistance properties (Reboul and Baroux, 2011). Corrosion resistance is optimum in environments with a natural pH range of 4 to 9. Out of this range, the aluminum oxide film that forms on the metal surface and protects the metal will degrade (Reboul and Baroux, 2011).

Higher carbon content and hardness in steel would make it susceptible to SCC or embrittlement (Light Truck, 1999). In addition, the type of coating used (metallic, wax, paint, electrocoat, etc.) should consider the metallic substrate to be protected and its service environment. Use of zinc coating on aluminum and steel sheet is effective at reducing corrosion. A direct relationship between corrosion and the amount of zinc coating on aluminum sheets has been observed (Uchida and Mochizuki, 2000).

Corrosion needs to become a high priority during material selection. Many studies have shown that T-7 has high corrosion resistant properties with only a 10% decrease in strength compared to T-6 temper (Shi,

2013; Phan, 2003; SOW, 1998). A common alloy that has been used for several decades and is still used today in aircraft is Al 7075-T6, which is very vulnerable to corrosion (Figure 29 and Figure 30). Alloys like 7150-T77, 7249-T74, 7050-T7451, 7055-T7751, 7150-T7751, 7050-T7651 and 7055-T7651 have better corrosion resistance and mechanical properties than 7075-T651 (Shi et al., 2013; Phan, 2003; SOW, 1998). Where stress corrosion cracking is the main problem, 7075-T6 can be replaced by 7050-T7451. Moreover, using this strategy will shorten the manufacturing time (Phan, 2003).

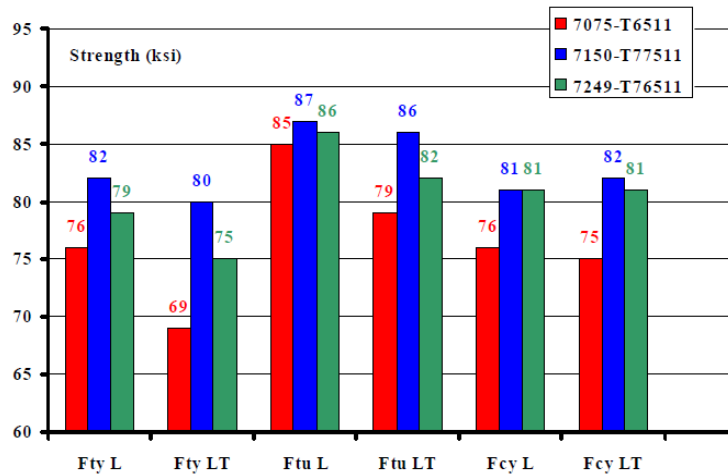

Figure 29. Wide extrusion mechanical property comparison (Phan, 2003).

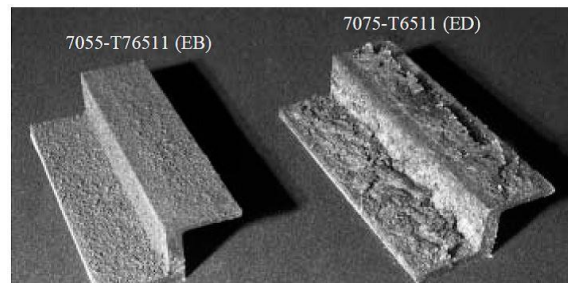

Figure 30. Exfoliation Corrosion Test (ASTM G34) (Phan, 2003).

5.2. Design Improvements

Corrosion prevention and control begins with material selection; however, the use of corrosion engineering principles in design can have a significant impact. If an operating environment is considered to be corrosive, engineered design of components should reflect this situation. For example, a **design should be used to avoid creating locations where water may accumulate**. A heat treatment process called Retrogression Re-Aging (RRA) is another approach to improve the corrosion resistant properties of designs (Agarwala, 2004).

A combination of environmental stresses can lead to the failure of automotive electronics, often initiated at the contact surfaces of connectors. As such, resistance to corrosive (chemical), thermal, and mechanical stresses is essential for connector reliability, and the corrosion protection of the connector and

contact surfaces can be achieved by proper design, materials selection, and the use of seals/grommets and lubricants (Payer, 1992). Some general trends in corrosion engineering design have been found to greatly decrease the detrimental effects of corrosion. For example, time of wetness has a direct impact on corrosion of materials, so the design needs to address this by **preventing water from collecting through the use of drainage holes or positioning techniques. Minimum diameter for all drains should be 9.525 mm (0.375 inches)** (CPC, 2007).

There are many corrosion prevention techniques and methods that can be incorporated into the specification, design, and fabrication of equipment. For example, the use of more resistant alloys that decrease the tensile stress can be helpful in situations where stress corrosion cracking dominates. Properly designed welded joints and gaskets should be utilized to minimize crevice corrosion. Contact between dissimilar metals creates galvanic corrosion and where ever possible should be avoided (Jones, 1996). On the other hand, these constant modifications in engineering design and fabrication present many challenges for decreasing corrosion without creating exceedingly high costs. More anti-corrosion design tips are listed as follows.

1) *Materials selection* is one critical part of the overall design process. Corrosion-resistant materials should be economical yet provide adequate resistance for the specified service conditions.

2) *Structures designed* for atmospheric corrosion resistance should always provide easy drainage from all exposed surfaces. General atmospheric corrosion is increased by any features that retain water. Avoid geometrical configurations that trap dust, moisture and water (Roberge, 1999). Channel and angle sections positioned to collect rainwater or debris increase the likelihood of corrosion; proper design configuration will prevent water collection or, if that is not possible, include holes for drainage. The undersides of constantly shaded panels are more susceptible to corrosion because time-of-wetness is increased when dew and condensation are not readily evaporated by the sunlight. Insulation or lagging in contact with metal surfaces can also collect and retain condensation or rainwater.

3) **Configuration of structures** should be as simple as possible. Design should allow maximum access for maintenance and repair painting. Avoid crevices and design features that make it difficult for protective coatings to function (e.g., sharp corners) (CPC, 2007). Box sections have poor access for coatings, collect water and debris, and maximize possibilities for corrosion. Edges and corners are difficult to coat uniformly, and thinly coated protrusions are susceptible to corrosion. On the other hand, the simple cylindrical structural members are preferred because they allow for ease and uniformity of paint application as well as convenient inspection (Aluminum Association, 2001). In general, the design (e.g., configurations and coatings) should allow **materials to drain properly and the drainage holes should be shielded or oriented to avoid direct road splash** (Figure 31 & Figure 32) (Roberge, 1999).

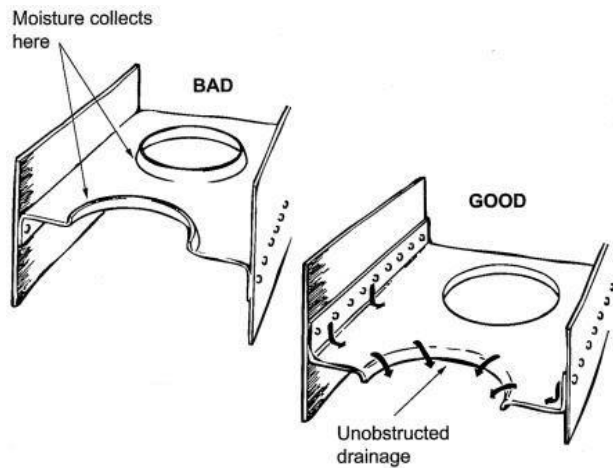

Figure 31. How to make proper holes in horizontal diaphragms (Roberge, 1999).

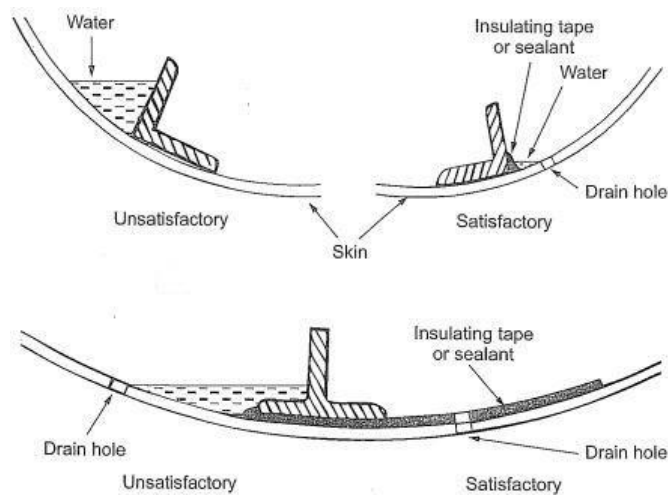

Figure 32. How to prevent water traps (Roberge, 1999).

4) *Stress corrosion cracking (SCC)* can be prevented by substituting a more resistant alloy, removing the tensile stress, or making the environment less aggressive. For example, in SCC of austenitic stainless steel by chlorides, substitution of duplex stainless steels will often (but not always) eliminate the problem. Attention may be required to use of very high strength steels (above approximately 965 MPa (140 ksi) yield strength), because these grades can suffer cracking due to hydrogen (NACE MR0175/ISO15156).

5) *Corrosion fatigue* can be prevented by eliminating cyclic stress or making the environment less aggressive. Vibrational stresses can be suppressed by a more **rigid design**. **Removal of notches and other stress-concentrating features** can be helpful, where feasible. **Rounded filets and angles** will also reduce stress concentrations.

6) *Galvanic corrosion* can be avoided by **using the same type of metallic material for the same structure**. If dissimilar alloys have to be used in electrical contact with each other, **galvanic corrosion can be controlled by selection of alloys that are adjacent to each other in the galvanic series** (Table 1). In other unavoidable couples, the anode alloy should be large in area compared to the cathode. **Both members of a galvanic couple should be coated, never the anode alone, to avoid any small anode area with coating defects**. **If feasible, dissimilar alloys should be electrically insulated from each other at their junction** (Figure 33 & Figure 34). In atmospheric corrosion, continuous moisture should not be allowed to carry corrosion products from a more noble to a more active metal to cause pitting of the latter (e.g. from copper to zinc-galvanized rain gutters or aluminum siding). **Crevices between dissimilar alloys should be avoided**, under which the corrosion is more serious than galvanic corrosion or crevice corrosion alone.

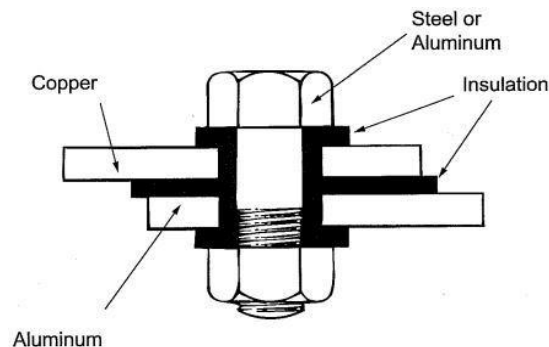
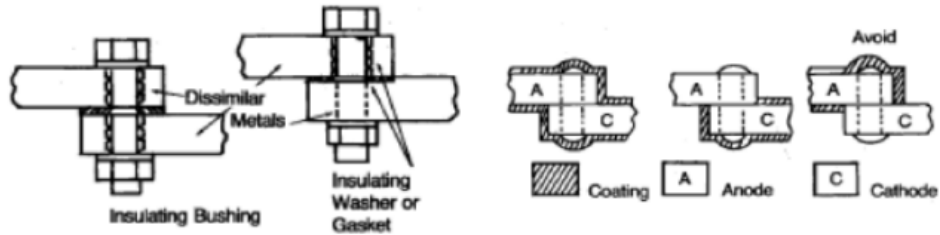
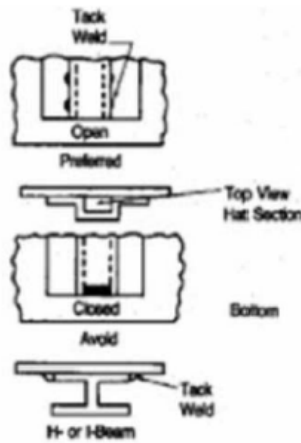

Figure 33. How to insulate two dissimilar metals against galvanic corrosion (Roberge, 1999).



Metallic fasteners which join aluminum to a dissimilar metal should be made of an alloy cathodic to aluminum. Sacrificial protective coatings, typically formed by epoxy resins containing zinc, applied to steel fasteners are very effective

Coatings should be applied to both the anode and the cathode or to the cathode only. Damage to the coating on the anode would result in serious corrosion due to small anode-large cathode combination. Sealants should be applied to crevices for best results.



Hat section and H- or I-beam reinforcements are good designs but the hat section should be open at the bottom for easy drainage.

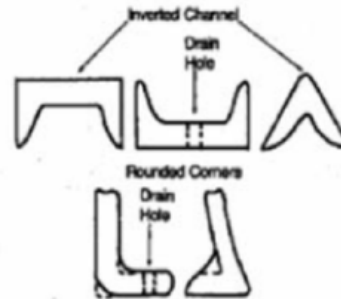

If not inverted, channels require drain holes to avoid entrapment areas; angle sections should have rounded corners, smooth tapers, and drain holes as indicated.

Figure 34. Schematic of some appropriate designs (Aluminum Association, 2001).

7) *Crevice corrosion* can be **minimized by proper design of joints and junctions** that minimize crevices. Welded joints are thus preferable to bolted and riveted joints, but the **welds must be properly designed and constructed** to eliminate crevices. **Gaskets must be properly sized** to minimize crevices exposed to the corrosive solution and should not use absorbent or permeable material. **Joints and crevices should be sealed** to prevent entry of chemical deicers (CPC, 2007). **Sealing compounds and inhibitive coatings** on flange faces also provide a barrier from chloride deicing chemicals (Figure 35 & Figure 36). Both crevice and pitting corrosion may be expected to increase in stagnant or slow-flowing solutions, where deposits and corrosion products can accumulate to create crevices. Therefore, the number of poultrics (mud, debris, etc.) traps, joints, exposed seams, and stone impingement areas should be minimized or avoided. Also avoid geometries that unnecessarily trap moisture (CPC, 2007). **Periodic cleaning** may be necessary to remove deposits. Tanks should be designed for complete drainage.

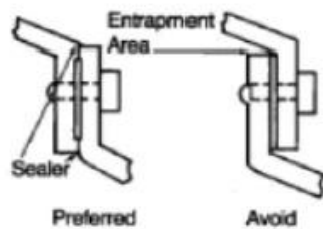

Design, and use of sealer, minimizes entrapment areas.

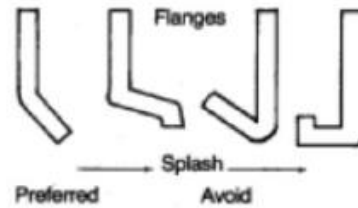

Flange orientation and design prevents entrapment of moisture and debris.

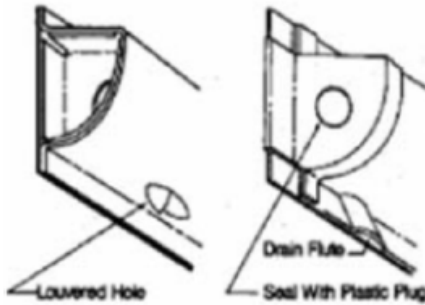

When box sections must be used, provide sufficient openings for the application and the drainage of protective coatings. Drain flutes and louvered holes should point down and to the rear of the vehicle. Crevices should be painted or sealed.

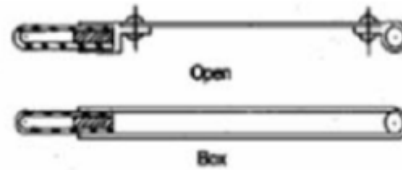

When box sections must be used, provide sufficient openings for the application and the drainage of protective coatings. Drain flutes and louvered holes should point down and to the rear of the vehicle. Crevices should be painted or sealed.

Figure 35. Plan of some proper configuration of structures (Aluminum Association, 2001).

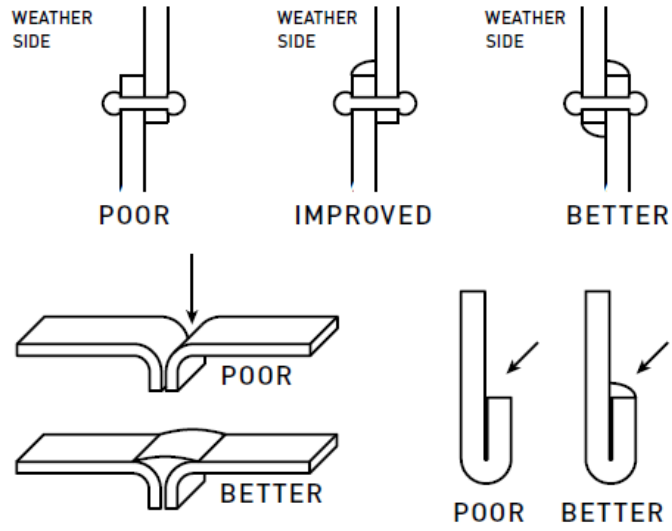

Figure 36. Some proper configurations (Eck, 2014).

5.3. Considerations for welded joints

The following considerations should be made for welded joints (Figure 37) (Resene, 2014):

- Eliminate the weld splatter using blasting or chipping.
- Rough welding should be ground smooth.
- If feasible, welds should be double coated.
- Where corrosion is possible, use continuous welds instead of discontinuous welds (tack or skip welds).
- Remove brackets and extra metal followed by ground smoothing areas of previous contact.
- Remove weld flux after finishing of welding.
- All joints should be completely sealed.

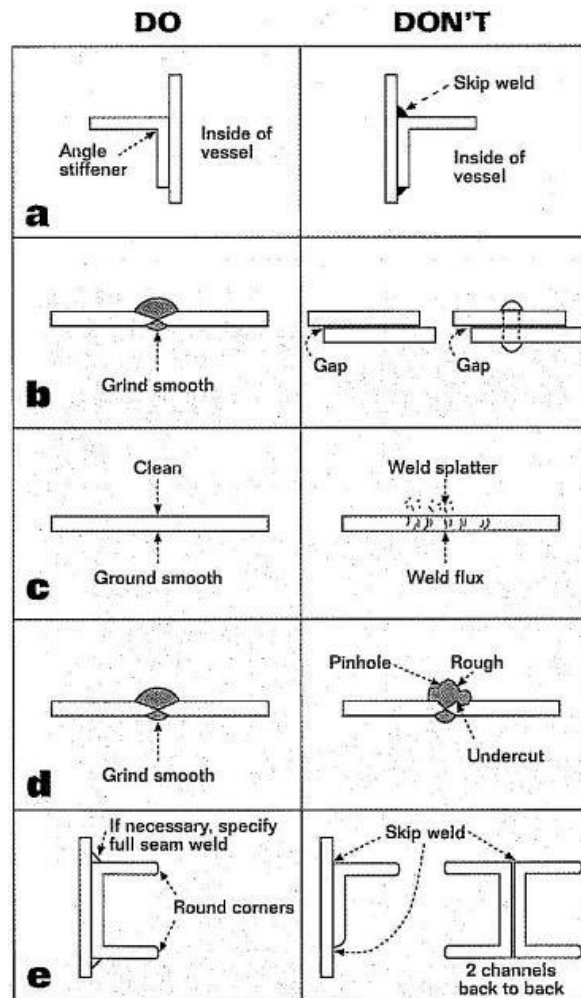

Figure 37. Schematic of some considerations for the welded joints (MP, 2005).

5.4. Coatings for Corrosion Protection (Anti-Corrosion Coatings)

Numerous corrosion coatings have been developed and tested in an attempt to combat the harmful effects of corrosion on metal. These **coatings must meet many requirements, and therefore must be long-lasting, easy to apply, environmentally friendly, cost-effective, and high performing.** Specific examples include:

- Conversion coatings such as phosphate, which improves the ability of paint to adhere to the metal surface
- Electro coating (e-coating or electrodeposition) and also electroless coating
- Metallic coating (often zinc or aluminum) and sacrificial coating (e.g., galvanizing)
- Mechanical plating
- Organic based coatings (e.g. polymer nanocomposite coating) and waxes
- Autodeposition and powder coating

Passivation is the other surface preparation technique for preventing corrosion. The use of this method is limited to those materials for which passivation is possible (Kruger, 2000). A typical approach to coating systems involves application of three types of layers:

- Most commonly, the first layer consists of a metal oxide.
- The next layer is a primer that contains inhibitors.
- The top layer is generally a barrier that separates and protects the underlying coatings from the surroundings (Sitaram et al., 1997).

Electrochemical deposition allows for easier and more effective coating of structures with intricate geometries, than dip and spin coating methods (Sheffer et al., 2003); whereas, electroless deposition is more effective than electrochemical deposition (Schlesinger and Paunovic, 2010). Increasing the thickness of a certain coating will generally increase its corrosion protection, but the corrosion protection provided by two different types of coatings cannot be related solely based on their thickness. For example, an aluminum coating that is a couple of micrometers thick protects steel better than cadmium and chromate coating that is tens of micrometers thick (Huttunen-Saarivirta et al., 2009). In addition, surface preparation is a key component in the success of corrosion protection coatings. The coating performance is significantly enhanced for a surface containing little or no contaminants (Jones, 1996) and **almost three-fourths of all coating failures happen as a consequence of poor surface preparation** (Frakes, 2014).

When replacing a coating that is no longer environmentally acceptable, it is important that special attention is given to the corrosion behavior differences of the coatings to ensure that the new coating is an acceptable alternative. For example, an ordinary coating that is applied to a well prepared surface may perform better than a high-quality coating that is installed over a substrate with inappropriate or poor surface preparation (Frakes, 2014).

When zinc-nickel coatings are replaced instead of cadmium layers it should be mentioned that zinc-nickel alloys exhibit localized corrosion and cracking, while cadmium layers are susceptible to uniform corrosion (Gavrila et al., 2000). Information on specific anti-corrosion coating products can be found in the report by Shi et al. (2013).

Due to the variations in the physical and chemical properties of the metals and alloys, protection provided by each coating is dependent on the type of metal it is applied to and the environment in which it is exposed.

5.4.1 Surface preparation methods prior to coating

Proper preparation of the metal surface plays an influential role in the lifetime of the coating, and includes a wide variety of methods and procedures that may involve grit blasting, mechanical removal of rust, or the use of rust remover. These countermeasures can be used individually or synergistically in the practices of managing the corrosive effects of deicers to motor vehicles and winter maintenance application equipment. A recently developed method is the use of rust converters. Rust converters are designed to convert existing rust into a protective coating that blocks moisture and prevents future corrosion problems.

Important practical points

- **Use of salt remover (rust remover) effectively increases coating performance (Peters, 2003)**
(Additional information on rust removers can be found in section

7.5.2 Washing).

- **Grit blasting is the best method of surface preparation (Figure 38). However, in situations where grit blasting is prohibited or unusable for safety and environmental reasons; rust removers should be used for surface preparation prior to coating (Sharman, 2009).**

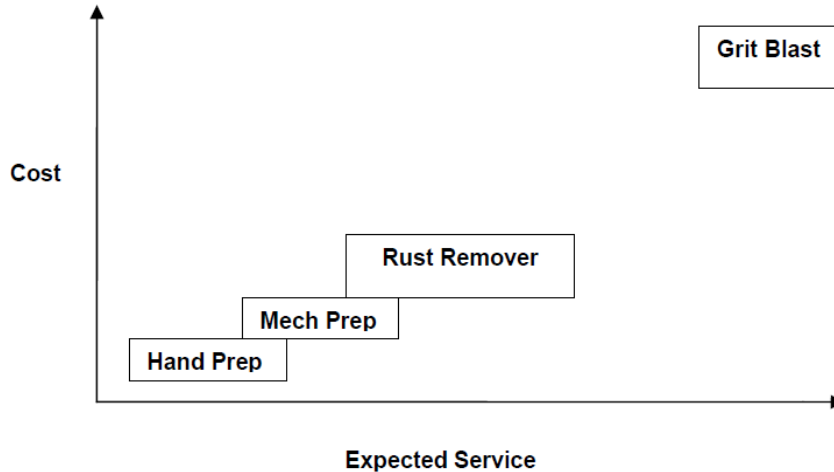

Figure 38. The cost versus expected service life of a coating applied by using various substrate preparation methods (Sharman, 2009).

- **In maintenance environments, rust removers should be used for surface preparation prior to coating; instead of traditional hand and mechanical wire brush (Sharman, 2009).**
- **When time is critical, time can be saved by using rust converter (The Rust Store, 2014).**
- **In the rusted surfaces, rust converters could be applied to the metal surface as a primer coat supplemented with oil based or epoxy paint (Collazo et al., 2008; Shi et al., 2013).**
- **Rust converters are not suitable for damaged coatings (Caseres, 2009).**

Rust converters containing copper compounds accelerate oxidation and have negative effects (Collazo et al., 2010). The majority of rust converters are made from tannic acid or phosphoric acid, or a mixture of both (Barrero et al., 2001). Well-performing rust converters consist of isopropanol and tertbutanol (Barrero et al., 2001). A combination of tertbutyl and iso propyl alcohol can be used to accelerate the efficiency of rust convertors (Bolivar et al., 2003). A report by Caseres (2009) provides a review of these specific products.

5.4.2 Reapplication of Coatings

One useful method for fast coating repair widely used by the U.S. Navy is direct-to-metal coating. The overall protection power of the self-priming topcoat (SPT) can be improved by mixing it with organic corrosion inhibitors, which produces an enhanced self-priming topcoat (ESPT) (Osborne et al., 2003).

5.4.3 A Successful Plan for Recoating

The following successful procedures for reapplication of coating are used by the Vermont Agency of Transportation (VAOT) (Courtesy of VAOT):

Paint

- Media blast the bodies, primed with a zinc primer, further primed with an epoxy primer, including interior of the rear corner posts, baked at the primer stage, and painted with a polyurethane paint, and baked again. Total thickness, primer, and paint, shall be no less than 8 mm dry (Figure 39 & Figure 40).



Figure 39. A vehicle which first sandblasted (left) and then primed and painted (right) (Chupas, 2014).



Figure 40. Corrosion damage on a winter maintenance vehicle (a), and in-field success of UV curable coating (b) (Monty et al., 2014).

- All processes to be completed in a temperature controlled, low humidity, level, and contained booth.
- No grinding or welding of the painted body – only “bolt-on” components can be added after the painting process is complete.

- Sand or shot blast all other components, prime with an epoxy primer, and paint with rust-resistant paint. Plow and wing moldboards should be orange to match body color; all other components black.
- All paint should be 100% lead free due to leads toxicity.

Undercoat and Seam Sealant

- The underside of the body, and the inside of the rear corner posts, should be undercoated with a long-life corrosion resistant coating, such as truck bed liner.
- Any and all open seams under the body need to be sealed with seam sealant prior to priming to reduce corrosion.
- A five year warranty on both materials and application should be provided. Periodic touch-up may be required to maintain the warranty. A copy of the warranty should be provided.

For a slightly different approach see Appendix C. U.S. Marine Corps Corrosion Prevention & Control Plan (CPCP), which is used by the U.S. Marine Corps and includes identified practices to reduce and prevent corrosion to vehicles.

Chapter 6: Repair, Rehabilitation and Retrofitting of Existing Equipment

Municipal Public Works agencies and State DOTs have long dealt with the problem of keeping worn equipment in service without expending exorbitant amounts of money, effort, and time. However, often these agencies have little choice in fiscal allocation when less money is allocated for capital budgets, the typical method of acquiring new equipment. Governing bodies have limited revenues, thus find it more expedient to allocate, for example, an extra \$15,000 in an annual operating budget, for maintenance of old equipment than \$180,000 for a new single-axle dump truck with plow and spreader. Thus Fleet Superintendents and Field Operations Managers must collaborate to identify which vehicles need work to restore to “front-line” (i.e., suitable for year-round use) condition and to reasonably extend their service life. For some vehicles the cost of repair and rehabilitation to front-line condition may be prohibitive; however, selectively choosing only maintenance options to make the vehicle safely operational and functionally reliable for a shorter span of time is an option. For example, a 10-year old plow truck that is mechanically sound but has a severely rusted dump bed and spreader is a good candidate for replacement of the entire bed and spreader (upgrading in the process to improved components) and spot repair/replacement of hydraulic, electric and pneumatic lines, and treatment of the chassis where needed. This could extend the service life another 5-7 years or more. On the other hand, a 15-year old truck with a body and spreader in fair condition but a history of frequent minor mechanical/electrical problems may be better choice for repairs necessary to keep it as a “back-line” or reserve truck for another season or two.

The process is similar to “triage,” a term common to the medical profession. Maintenance and Operations managers must decide what is not economically feasible to save; what can be retained but needs extensive work, and lastly, what still has a long service life but needs some minor work to keep in top condition.

6.1. Evaluation Process for Fleet Vehicles

- **a thorough inspection and operational check of each unit;**
- **an initial itemized list of repair/maintenance work for each vehicle;**
- **a general assessment rating using a standardized grading (alpha-numerical or defined term);**
- **a priority ranking for each item, for example: Critical, Urgent, Needed, Recommended;**
- **a detailed cost estimate for each vehicle;**
- **a determination of expected service life if repairs/rehab are done;**
- **a decision for the course of action for each unit of equipment (Routine Maintenance Only; Selective Repairs; Full Repair/Rehab; Defer and Re-evaluate within ___ days; No Maintenance or Repair-Deadline; Remove from Fleet by Sale, Trade-In, Transfer)**
- **final cost estimate based on evaluation.**

A numerical scale ranging from 1 to 5 is used by the Federal Transit Administration (FTA) to describe the condition of transit assets (Table 7). This scale corresponds to the Present Serviceability Rating formerly used by the Federal Highway Administration to evaluate pavement conditions. A rating of 5, or "excellent," is synonymous with no visible defects or nearly new condition. A rating of 1 indicates that the asset needs immediate repair and may have a seriously damaged component or components (FHWA, 2014).

Table 7. Serviceability Rating used by the Federal Highway (FHWA, 2014).

Rating	Condition	Description
Excellent	5	No visible defects, near new condition.
Good	4	Some slightly defective or deteriorated components.
Fair	3	Moderately defective or deteriorated components
Marginal	2	Defective or deteriorated components in need of replacement.
Poor	1	Seriously damaged components in need of immediate repair.

An example fleet audit and assessment of the Washington D.C. Fire and Emergency Medical Services Department’s fleet inventory and maintenance operations to further improve fleet management is provided in Appendix D. Fleet Composition and Replacement Example Audit. Though it focuses on fire trucks and ambulances most of the findings and recommendations readily apply to the snow and ice control fleets of Public Works and DOT agencies (DC Fire and EMS, 2014).

6.2. Repair and Restoration Process

6.2.1 Removal of Rust and Corrosion

- Remove the corrosion layer, which is often rust. This will aid in the inspection of the vehicle components for preventing failures and performing suitable maintenance.
- Inspect equipment using a scraper and “sounder,” such as a small ball peen hammer tapped around a suspect area, or a “probe” such as a long screwdriver. A long-handled spot mirror is also useful. Often what looks fairly good on the surface turns out to be almost nothing more than a thin veneer of blistered paint and rust. Inside the operator’s cab, look underneath seats and floor mats, because operators’ footwear brings in a lot of snow that melts and deposits material in these hidden areas. Depending upon the severity and extent of corrosion, digital photos or video may be warranted to provide a baseline for repair work.

- Treat the vehicle body or chassis components by mechanical means (scraping, brushing, sand blasting, cutting or punching) or chemical (application of rust removers). The key factor in this step is to thoroughly remove all affected material. After the incipient corrosion is removed and bare metal is exposed and cleaned, then rust preventive primers are applied followed by top coats of paint where needed.
- Inspect electrical connections and joints in hydraulic, fuel, and pneumatic lines very carefully for any signs of corrosion.
- Where dissimilar metals are joined, they should be separated by use of inert separators.
- Engine, drive train, suspension, steering and braking components that exhibit rust or corrosion are often difficult, not feasible, or impossible to repair; it is usually more expedient and economical to just replace oil pans, exhaust system parts, motor mounts, u-joints, springs and shackles. This also applies to certain parts of the on-board material application systems such as conveyors, spinners, spray bars, and tanks. Inspect wheels, particularly lug bolts and nuts. It may be advisable to wrench a few back turns on each lug nut to make sure they have not seized from corrosion. Check tires for proper pressure, deformities or severe wear.
- Inspect plow blades, casters or skids, mounting rigs, safety chains and control cylinders. Pay attention to fluid or lubricant leaks. During this process other preventive measures can be taken such as sealing crevices, cracks, and openings.
- Replace missing or deteriorated gaskets and seals around access holes for wires, cables, or lines, as well as gaskets around doors and windows and sealant where mounting hardware (screws and bolts) for external equipment perforates the body or chassis.
- Inspect all external lighting components for cracks or holes in lenses or deteriorated gaskets that allow water to enter.
- Inspect radiator, transmission cooler and belt pulleys. Look for corrosion, but also look for wear or damage caused by abrasive materials or impact from debris. Though corrosion does not affect rubber it will affect the metal clamps. It should be noted here that calcium chloride can be harmful to non-metal parts.



Figure 41. Before rebuild (left), after (right) (Chupas, 2014).

Restoration differs from repair mainly based on the severity and extent of remedial work needed to return the vehicle to full operational capability and reliability. For example, removing scattered rust spots and repainting a dump body is a repair; replacing the entire body and material applications systems is a restoration. Restoration usually requires a considerable expenditure of time and money and is typically justified to keep a unit past its expected service life. An agency may be forced into such a situation if funds are not available to purchase a new similar vehicle or if the unit will be placed into a reserve status. Snow and ice operations require a certain number of specially equipped vehicles; a type that is not easily obtainable by renting or leasing on short notice.

6.2.2 Modifications

Certain modifications can be made on older units to aid in corrosion prevention. One example of this is replacing rotating or strobe warning lights mounted directly on the cab roof with ones mounted on a cross-bar that clamps to the roof gutter channels. The same can be done with radio antennas. This eliminates penetration of screws and cables through the roof that are often difficult to keep weather-tight.

Chapter 7: Preventive Maintenance Practices for Equipment

7.1. Operator Inspections - In-Season and Post-Season

Vehicles and other equipment used in winter weather operations are also used year-round for other maintenance activities. A generally accepted practice is for the operator of any vehicle to **inspect the unit prior to using it**, even if it had been used earlier in the day by someone else. In reality, compliance with that is often inconsistent. Some operators do a thorough inspection according to agency format; others will do a very cursory check and some will do nothing except fill out a form. During the snow season, management must emphasize the importance of complete inspections at the beginning of each shift and **reporting of any problems encountered by the operators**. Though this primarily covers mechanical and electrical systems, it can also aid corrosion prevention. In some cases, a problem may be caused by rust or corrosion that is not readily apparent. For example, an operator may report intermittent problems with tail lights. Upon closer inspection it may be determined that corrosion on terminals is the cause. Or, an operator may report that the truck body seems to list to one side; inspection reveals a suspension shackle has rusted away. Loud noise from the exhaust system? Rusted header pipe from the engine. Smell of burning oil or oil leaking on the floor? Corroded oil pan.

At the end of the season, vehicles should be thoroughly cleaned and top-to-bottom, end-to-end inspection of the chassis, body and engine compartment should be performed. The inspection should be performed even if the unit will be used immediately for other maintenance work. The seasonal change-over from winter operations to regular maintenance work is an opportune time to implement corrective and preventive measures, especially on equipment that will be stored during the summer, or if remaining on the vehicle, will not be in use during that time. For example, the plow apparatus should be cleaned, rust and corrosion removed, hydraulic control hose ends greased and bagged or capped, and chains replaced if needed. Plow hitches or frames should be inspected for damage and pivot points greased.

Many agencies use a “V-box” that is installed in the dump truck bed during winter operations; the same preventive approach applies as well. For a combo bed, one that is converted from winter material spreading operations to a dump body by installing a cover plate over the in-floor conveyor, the moving parts of the conveyor need to be cleaned and greased. The tail-mounted spinners should be removed and treated. It is particularly important to keep the quick-connect hardware on the hydraulic hoses covered during the off-season.

Fleet and Operations Managers should also be cognizant of the proper storage of the seasonal hardware. If kept outside, the units need to be either under cover or in a location or position so that rainwater drains off and away. They should also be stored neatly and away from other equipment so that they can be periodically checked during the summer.

Two primary ways to deal with corrosion are reactive and preventive. Reactive methods are used to deal with existing corrosion by cleaning corroded parts with a rust removing compound, or replacing the ones that are too far gone for rehabilitation. A reactive treatment may in some cases be the most cost effective means of dealing with corrosion if the parts are easy to clean, or easily replaced and fairly inexpensive. Preventive methods are the proactive strategy which may involve the use of corrosion resistant materials for equipment components, dielectric grease, enclosed wiring connections, the use of

sacrificial anodes, the use of coatings, and the use of corrosion inhibited products. Frequent and regular washing of equipment can be considered a preventive strategy (Mills, 2012).

7.1.1 Tips to Protect Your Snowplow From Corrosion

Snow plows are still at risk for corrosion in summer months due to heat, humidity, and condensation if not properly dealt with. The following steps identified by Phelps (2013) can be performed during the winter and in the off-season to help prevent corrosion.

1. **Wash your plow** – During the season, it’s hard to wash your snow plow after every snow event, but at the very least make sure you wash your snow plow (truck and plow) before you put it away for storage. If you plow heavily salted roads and parking lots, then you may want to wash it more often throughout the winter to prevent the corrosive salt from building up (Phelps, 2013).
2. **Rust spots** – Your snow plow is a work horse and it is going to get dinged up. After multiple years of use you will start to see rust locations (mainly at areas of contact). Before you store your plow for the summer check for rust. If you notice rust in any locations, wash the area, sand off the rust, and repaint. This will give the metal a protective coat while it is in storage (Phelps, 2013).
3. **Grease contact points** – After each wash, before you store your plow, and before you take your plow out for the season, grease all the moving contact points. For example, the center pin (V-blade), the bolt that holds the quad and pushbeam together (straight blade), exposed chrome on straight blade cylinders, cylinder mount locations, SmartHitch pin locations, and the points where the pushbeam or A-frame connects to the coupler are some of the areas you should focus on when greasing the moving contact points. You can use a penetrating lubricating oil, like WD-40®, a low temperature silicone spray, or a low temperature lithium grease, just to name a few (Phelps, 2013).
4. **Check electrical connections** – Before and after each season, you should go through your electrical connections and make sure they are not corroding. If you see corrosion beginning to build up, there are steps you can take to prevent future connection issues. First, make sure there is no power going to the area you are cleaning. On the truck side, disconnect the battery, or on the plow side, disconnect the plow from the truck. Remove the plug or terminal that needs attention. If the plug or terminal is loose or broken, make sure it is replaced. If the plug or terminal appears to be in working order, then use a small wire brush to clean off the corrosion. Once you have cleaned or replaced your connectors, add dielectric grease to all terminals before plugging them back in. This step is important because dielectric grease prevents dirt, water, and salt from gathering on the connection and causing corrosion problems (Phelps, 2013).
5. **Storing your plow** – Your plow should be stored in a cool, dry place in the summer. A garage, pole barn, or lean-to are all adequate storage locations. In the event you cannot store your plow under a roof or on concrete, make sure when it is stored outside that it is sitting securely on blocks or 2x4’s. In all stored locations your plow should be covered; however, the cover should not be air tight. Tight covers can collect condensation underneath and can result in damage to your snow plow (Phelps, 2013).

7.1.2 Snow Plow Storage

The following are some pointers for snowplow storage developed by Meyer Drive Pro. (2008).

- **Disconnecting** – When the snow plow is disconnected, extend the lift cylinder to the end of stroke and coat the chrome rod with light grease. This will fill the cylinder with hydraulic fluid and protect the interior and exterior from rust and corrosion.
- **Coating cylinder rods** - Whenever the plow is disconnected, coat the exposed portions of the power angling cylinder chrome rods with light grease to protect them from corrosion.
- **Coupler protection** - Be sure to reconnect optional quick couplers at the power angling rams to keep them clean and prevent contamination of the system.
- **Lubrication** - Coat all pivot pins and other wear points with chassis lubricant.
- **Electrical connections** - Unplug all electrical connections at the power unit. Coat all connections with a dielectric compound to prevent corrosion and plug into their corresponding weather plugs. Unplug the snow plow lights, tape or use a dielectric compound at light connections to prevent corrosion.

7.1.3 Avoiding plow breakdowns

The following best practices for avoiding plow breakdowns were identified by the Accredited Snow Contractors Association (ASCA, 2014).

- Training – every operator, annually for novice and experienced staff.
- Proper and safe equipment operation
- Utilize pre-season time – for repairs, training, and practicing preventative maintenance.

Tip 1: “Grease all electrical connections to protect against corrosion.”

This is may be the most important post-season maintenance step. Use a non-conductive dielectric grease to seal out moisture from the electrical connections, preventing corrosion that can destroy the electrical system. This small step can save time and money.

Tip 2: “Clean and paint all scratches and nicks in the powder coat (powder coated paint) to protect against rust.”

Any nicks or scratches that show exposed metal have the potential to rust. These areas should be inspected, cleaned, prepped and painted to ensure that rust does not have the chance to set in.

Tip 3: “Fully collapse the lift cylinders and lubricate the chrome rods to protect the hydraulic system.”

Lubricating the chrome helps prevent rust and helps keep contaminants out of the hydraulic system. Rust on the chrome lift rods could potentially flake off and enter the hydraulic system, leading to costly repairs. Fully collapsing the lift cylinders and lubricating the chrome rods protects the hydraulics, nearly eliminating the risk of contamination.

Tip 4: “Drain the hydraulic fluid to eliminate moisture build up.”

Drain all of the hydraulic fluid prior to storage, to ensure that there is no moisture build-up that can lead to performance issues or rust. Condensation that forms in the hydraulic fluid can build up, and it is possible for the reservoir to rust from the inside out.

Tip 5: “Perform a thorough inspection of the iron.”

Perform an in-depth check of the plow, looking for wear, metal fatigue, cracks or any other issues that may influence performance. Check all of the welds, re-torque the nuts and bolts and make sure everything is solid.

In addition to these five tips, a little common sense can go a long way.

Vehicle inspection - By simply checking your plow on a regular basis and keeping up on simple maintenance, you can add years to the life of the plow. A good visual inspection should be done daily in average snow season. If it's a really slow snow season, you really don't need to inspect it as often. Conversely, if it's an above-average season, inspections may be required twice a day, during a break or before heading out to the next client's site.

Six-point check list for a visual inspection of a vehicle.

1. Cutting Edges – If a section is damaged or worn, replace it.
2. Center and Outer Springs – Be sure they're all still intact and not loose.
3. Mounting blocks – Be sure none are cracked, chipped or damaged. Be sure the fasteners are there and secure.
4. Side Panel – Be sure the nuts and bolts are all still present and tight. Also check the locking cotter pins are there. And be sure the bushings are not worn.
5. Wear Shoes – Again, be sure all nuts and bolts are present and tight. Shoes should be replaced if worn. That's likely something that you'll notice at the end of one season or multiple seasons. The shoes should never get so worn in one day that they need to be replaced frequently.
6. Slip-Hitch – Check the pins and lock bolts.

Look for anything that is missing, loose, worn, cracked or damaged – basically anything that should be replaced.

Timely maintenance - Proper and timely maintenance is key to ensuring top performance as well as avoiding accelerating the wear of components. The frequency at which equipment is checked may vary and can be determined by mileage, fuel consumption, service hours or calendar time.

Check Oil Level - Always check fluid level with the lift piston fully retracted. The fluid level should be at the appropriate level. If your fluid is low or appears excessively dirty, refer to the owner's manual for instructions on filling and changing the hydraulic fluid.

Monitor the condition of hoses - Check all hoses for bubbles or cuts and couplers for rust or leaks. A failure in a hose or coupler will result in a loss in oil pressure and cause power angling failure.

Monitor the condition of couplers and rams - Check rams for rust and leaks, either of these problems can introduce water into the hydraulic system, which may cause freeze-ups. If any of these problems are found, replace the damaged parts.

Monitor the Electrical System and Battery Terminal Connections - For maximum efficiency, the vehicle supporting the plow must be properly serviced. The system should consist of at least a 70-amp/hr battery and a 60-amp alternator. Be sure to regularly check the battery terminals to assure they are clean and free of corrosion; adding dielectric grease to all connections will help prevent corrosion from occurring. Also check the electrical connections to assure they are tight and corrosion free. Make sure all wires are being held clear from moving or hot engine parts or from sharp sheet metal. For maximum efficiency, the battery, alternator and regulator must be in top operating condition to assure maximum electrical output.

7.2. Mechanic inspections – routine and special

Mechanics, because of their training and experience, have an especially important role in corrosion prevention. They not only know what to look for but the very nature of their work physically positions them to better look at all parts of a unit. Even on a nice day an operator is not going to crawl under the vehicle he is inspecting to look for hidden signs of corrosion. However, when a mechanic has that same unit on a lift in the garage he is more likely to observe such problems.

Mechanics perform routine preventive maintenance periodically on vehicles or equipment so they have the opportunity to check also for corrosion or rust at these times. Likewise, if the unit comes in for unscheduled repairs, the mechanic should take a few minutes to check for potential problems. For example, if replacing a flat tire check the condition of the lug bolts and nuts, the wheel rim, the brake drum, and the springs and shackles for signs of corrosion.

One especially important component of the dump truck chassis that must be checked is the frame. Due to the design and construction, frame members tend to collect rock salt. These accumulations, mostly in areas difficult to see or access, tend to be overlooked during washing. In the course of a few years, the corrosion can seriously weaken the structure and the frame could break. This may occur when the truck has a full load of salt and is on the road.

7.3. Supervisor checks

Supervisors are responsible for ensuring compliance with procedures and practices regarding vehicle inspection and operation. Frequent, random spot checks are one way to determine if employees are properly performing inspections. Employees who are not performing adequate inspections should be counseled. The idea is to impress upon employees that the inspections are necessary to correct problems before they become worse. Supervisors may need to accompany an operator during an inspection as casual conversation often leads to mention of concerns by the operator of things that have been noted before but not corrected.

7.4. Plowing, Spreading and Spraying Methods and Techniques

Operators should be trained on proper snow and ice control methods and practices. Annual training for all, including contractors, should be mandatory. Veteran operators may need no more than a refresher on agency policies, but if there have been changes to what materials are used or application rates, or to plowing and spreading patterns, then all operators, regardless of experience, must receive the same information and instruction.

As for how this relates to corrosion prevention, reductions in the use of salt, or any chloride based product, either from change in application rates or by substitution of other chemicals mean less overall exposure. It may not have an immediate direct effect, but for the long-term it could have some positive impact.

7.5. Post-Storm Cleanup; Processes and Products

At the end of each storm, trucks and other equipment need to be thoroughly washed. Sometimes that is not possible due to either another approaching storm or temperatures that are extremely low. Some debate exists as to the temperature the wash water should be or whether to use high-pressure or low-pressure washers. What is most important is to wash away salt and other corrosive chemicals from any place on the vehicle where it could accumulate. Some agencies also use a rust preventive after washing.

A number of agencies have a practice of keeping plow trucks fully loaded with salt and parked in a warm garage. That may be practical for the regions that get a lot of snow storms, but for many it is more common to un-load the material and wash the trucks. One thing to consider about keeping a loaded truck inside a warm garage is **the salt on-board is likely slightly damp and the warmth will hasten chemical action**. If a loaded truck is needed to be kept on standby for the season, it is recommended that it be parked under cover outside with a block heater.

There are many technologies available to prevent or mitigate the corrosion of metals including **after-assembly coatings, salt removers (also known as salt neutralizers), spray-on corrosion inhibitors, and frequent washing**. An effective approach to prevent corrosion is the application of surface protection, essentially a barrier placed over any metal surface. This can be achieved in a number of different ways. First, surface treatments such as the application of paint can reduce the contact between the metal and moisture, thereby preventing corrosion. Passivation of the surface may also be considered, although this approach is limited to specific materials, for example the anodizing process for aluminum which leads to the formation of a protective aluminum oxide on the surface of aluminum substrate (Kruger, 2000).

- Corrosion resistant steel castings, silver soldered joints and spot welded assemblies should not be passivated (CPC, 2007).
- Rough surfaces, crevices, slip joints and bellows that can trap cleaning or passivation solution should not be passivated (CPC, 2007).

Adding inhibitors to ice control chemicals is another method to minimize corrosion. However, there are a number of issues that still need to be addressed in order for the use of inhibited chemicals to be determined to be efficient and effective. Tests measuring the corrosivity of various chemicals, with and

without inhibitors, provide very different results depending on the test used, the concentration of the chemical tested, and whether the test is conducted in the laboratory or the field. There are some practitioners who are firmly convinced that inhibitors reduce corrosion in maintenance equipment, and others who do not believe they are effective at all. **No consensus exists as to how much the use of such inhibitors extends the service life of equipment**, thus making any calculation of benefit–cost ratios impossible (Nixon and Xiong, 2009). Adding inhibitors to ice control chemicals have the potential to reduce the corrosion rates on vehicles, but for other equipment a better way to minimize corrosion is needed.

It is suggested that regular washing and the use of environmentally acceptable corrosion inhibitors and aftermarket rust-proofing (coating formulations able to displace moisture and penetrate corrosion product layers) can both be effective solutions in mitigating deicer corrosion to vehicles (Palmer, 1992). Assuming a twenty-year life, annual savings generated by an automated washing system in comparison to simpler wash systems would be in the range of \$100,000 to 500,000. Automated washing systems are ideally located where many vehicles are stored to maximize potential use, but such systems are unlikely to be viable at locations with less than 20 vehicles (Nixon and Xiong, 2009). Recommendations on epoxy types and salt neutralizing cleaning products were made by Mills (2012).

7.5.1 Inhibitors for Corrosion Protection

Corrosion research is concentrating on various preventative strategies in order to mitigate the harmful effects of corrosion. One of these research areas comprises the use and creation of effective, nontoxic inhibitors. Corrosion inhibitors, as defined by the International Organization for Standardization (ISO), are “compounds that when present in a corrosive system at a sufficient concentration, decrease the corrosion rate of metals without significantly changing the concentration of any of the corrosive reagents” (Kuznetsov, 2002) (Figure 42).

Key Points about Corrosion Inhibitors

- Adding inhibitors to ice control chemicals can minimize corrosion (Nixon and Xiong, 2009).
- Chromate inhibitors demonstrate the highest corrosion inhibitor performance but are toxic and harmful to the environment (Shi et al., 2013).
- Periodically spraying a corrosion inhibitor (Krown T40, e.g., 16 times per year) can effectively protect aluminum, stainless steel, and carbon steel components against corrosion related to deicers, by reducing their corrosion rate by at least 99%. Similarly, a one-time application of protective coating (Rust Bullet) reduced their corrosion rate by at least 99.5% (Shi et al., 2013).
- Inhibitors can be incorporated into coating systems, in which the coating contain a physical barrier layer and a conversion layer with an inhibitor.
- Agricultural products containing carbohydrates such as molasses obtained from sugar cane, sugar beets, or other similar syrups are used as corrosion inhibiting additives for liquid deicers and anti-icers (Hartley and Wood, 2009).

- Some non-toxic oxyanion compounds used as corrosion inhibitors include molybdate, organic thioglycolates and phosphonates, while some inorganic compounds used as corrosion inhibitors include phosphates, borates, silicate, and surfactants (El-Meligi, 2010).



Figure 42. Marine grade corrosion inhibitors can be used effectively for protecting brake valves, hydraulic fittings etc. (Chupas, 2014).

- The salts of sugar acids like aldonic and aldaric acids are much more effective corrosion inhibitors for deicing compounds than simple sugars, and can be used at lower concentrations to obtain the same effect as a higher concentration of a simple sugar (Koefod, 2010).
- The effects of temperature, UV, and other parameters are generally insignificant for sodium chloride and magnesium chloride with added corrosion inhibitors, but may be significant for calcium chloride with corrosion inhibitor (Mills, 2012).

7.5.2 Washing

Washing is a very effective way to reduce equipment corrosion (Nixon and Xiong, 2009) (Figure 43 & Figure 44).



Figure 43. Automated truck washing (Clonch, 2014; Chupas, 2014).

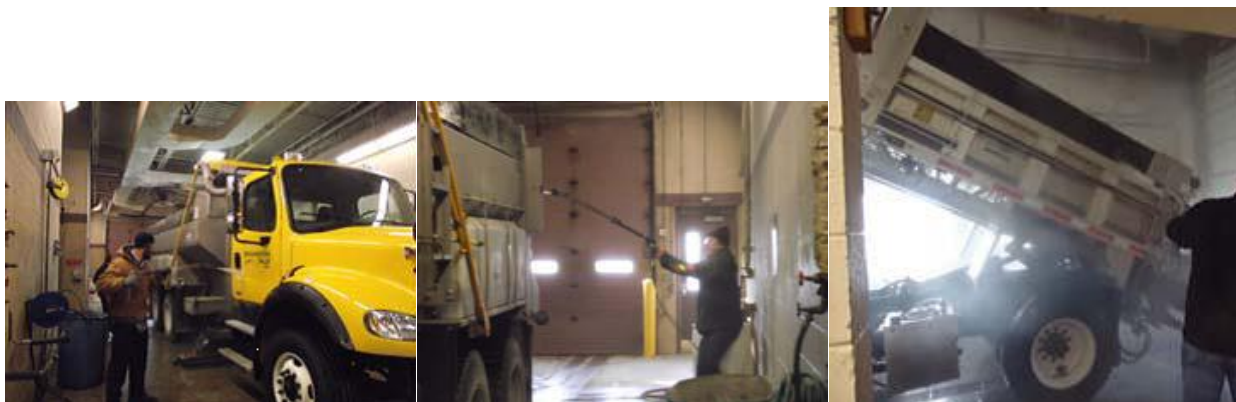

Figure 44. Truck washing by hand with a power washer (Clonch, 2014; Chupas, 2014).

Here are some specific points that should be considered in a washing program:

- Wash vehicle daily especially following anti-icing activity to reduce chloride salt build up (Mills, 2011).
- Wash underneath of the chassis and any place where water may gather (OAVET, 2014).

- Washing should be concentrated on trouble spots like frame rails, brake components and other areas that tend to collect materials (Shi et al., 201).
- Washing should be followed by localized cleaning and then fast drying (Shi et al., 2013).
- Perform routine washing preferably with hot water (AFRC, 2003)
- Preferably do not use a pressure washer, because water can be forced into areas and cannot escape which leads to corrosion (Mills, 2011).
- Use low pressure wash and high volume (flow rate) of about 300 psi/300 gpm (Clonch, 2014).
- Use physical action together with washing to remove the road salt (Lockridge, 2007).
- More cleaning liquid is not necessarily better - in some cases, a high concentration of washing compound may actually attack some of the plastics that are there to provide corrosion resistance (Lockridge, 2007).
- Wash radiator/AC condenser regularly (OAVET, 2014).
- The potential of coated components to resist corrosion damage depends on the type of alloy and washing procedure (Monty et al., 2014).
- Once active corrosion of metals has started, washing should be coupled with other means, e.g., applying spray-on corrosion inhibitor immediately. After the equipment is washed clean it should be dried (Shi et al., 2013).
- Other methods of aftermarket rust-proofing may include the application of post-assembly coatings (Shi et al., 2013).
- In cold locations, consider washing and drying vehicles indoors to avoid freezing up the equipment.

Salt Neutralizers

Salt neutralizers help remove salt from vehicles, and can be used to enhance the washing process:

- Washing with water alone or soap and water together is not sufficient for removing residual salt. The use of salt neutralizers (or salt removers) is strongly recommended (Monty et al., 2014).
- Use salt neutralizers after pressure wash as high pressure wash can cause capturing of salt and water at crevices, which can cause crevice corrosion (Monty et al., 2014).
- The effectiveness of salt neutralizers is alloy specific, therefore **using the incorrect salt neutralizer can even accelerate corrosion** (Monty et al., 2014).
- Without using salt neutralizer, coated carbon steel will be highly prone to corrosion, while coated aluminum and stainless steel alloys are much more resistant (Monty et al., 2014).

- A possible approach is using an acidic salt remover followed by the use of an alkaline salt remover (Shi et al., 2013).

7.5.3 Proactive Methods for Diminishing Corrosion

Based on extensive research, this section provides some proactive methods for reducing corrosion (Lockridge, 2007; Shi et al., 2013; Mills, 2011 and 2012; WSDOT, 2011; TRB, Special Report 235; CPC, 2014; OAVET, 2014; Smith, 2014 and Chupas, 2014).

7.5.3.1. Electrical Issues

- Eliminate the junction boxes wherever possible, and relocate them to inside the cab off the floor.
- Move the relay and circuit breaker for spreader controls that are mounted in the battery box into an enclosed box inside the cab of the truck.
- Move the electronic control module (electronic brain) inside cab.
- Mount electrical junction blocks in cab.
- Position wiring to reduce damage to the outside casing of wires.
- Use plastic or composites instead of metal whenever possible.
- Use weather tight electrical connections.
- Install sealed LED lighting.
- Keep water drained from the air conditioner system.
- Do not probe the wires to test for continuity and avoid any damage of wiring insulation.
- Avoid splicing into wiring.
- Do not pierce wire jacketing.
- Use a heat shrink terminal that seals out moisture especially in the case of any wiring repair.
- Use high-quality weather-proof terminations (e.g., buss-style connectors) and compression fittings in addition to shrink wrapping susceptible electrical wiring components.
- Use dielectric silicone for sealing damaged areas or connections.
- Install sealed wiring harness front to rear.
- Seal electrical systems (e.g., connectors, switches, and circuits) using adhesives, deadeners, and sealers (e.g. polysulfide).
- Sealed connection wires performed much better than butt connections, and wire probes should be avoided to prevent intrusion.

- Apply a non-conductive, non-sodium based di-electric grease on all electrical connections (e.g. plugs, sockets, pigtails, battery terminals, etc.)
- Make clean the electrical connectors on a regular basis (at least every six month) with water (not soap) and a wire brush, and re-grease with dielectric grease.
- Minimize connectors to the extent possible by using continuous wiring.
- Use anti-corrosive spray for protecting the battery posts and terminals.
- Do not apply paint to the rubber seals around lights.
- Install modified protective cover for battery.

7.5.3.2 Brake Components/Chassis

- Inspect all brake components even by removing brake drums to checking the entire lining surface and the brake shoe web, rollers, cam, etc.
- Install corrosion sealed air brake chambers.
- Spray on protective coatings on all brake valves.
- For all vehicles, especially five years and older, pull brake drums on a regular basis.
- In the rebuilding process specify rust-proof painted and epoxy-coated brake shoes.
- Use sealed brake canisters and sealed protective boxes surrounding hydraulic components, and replace with new style when necessary.
- Specifications require throttle, brake, and clutch pedals to be suspended vs. floor mounts.
- Specify self-healing undercoats, full fenders and fender liners for chassis.
- Use rubberized undercoating for aluminum brake valves.
- Be careful about automatic slack adjusters (ASA). Make sure ASAs are thoroughly lubed and there is no evidence of internal rusting.
- Require throttle, brake, and clutch pedals to be suspended in specifications.
- Install a large full width, full height under chassis sand guard on all front discharge sanding bodies.
- Use plastic quick release brake valves instead of aluminum.

7.5.3.3 Frame/Body/Beds and Other Parts

- Replace certain corrosion-prone components (e.g., carbon steel) with corrosion-resistant materials such as stainless steel, aluminum alloys, and plastics-and coated metals, such as clad steel, zinc

alloys, and galvanized steel or non-metallic (e.g. poly or composite materials) or a corrosion resistant material or parts wherever possible or inspect and replace on a regular basis.

- Steel fuel, hydraulic and air tanks can be replaced with aluminum tanks.
- Replace standard e-coat steel painted wheels with powder coated versions.
- Use powder coating for fuel tank and frame rails.
- Replace carbon steel oil pans with more expensive zinc or stainless steel oil pans.
- Consider buying stainless steel truck boxes, pre-wetting tanks, and sanders.
- Use zinc anodes in solution tanks.
- Use stainless steel couplers.
- Stainless steel under tailgate spreaders.
- Use poly faced snow plows to reduce corrosion and also lessen weight.
- Use stainless steel cooler lines for Allison transmissions.
- Use greaseable tailgate linkages and attach them to onboard automatic lube system.
- Replace radiators every two years (based on Washington State DOT experience).
- Use high-quality weather-proof terminations (e.g., buss-style connectors and compression fittings), high-quality primers and topcoats in equipment specifications.
- Do not use wheels with cracks, dents, leaks, severe wear, or rust pitting.
- Truck frames should be coated, sandblasted and painted as needed.
- Paint thickness on each side of wheel mounting face should not be more than 3 mils.
- Use rear mounted material application equipment as much as possible.
- Install zinc nickel alloy engine oil pan.
- Install grit guards on wheels (prevents wheels from rusting together and to the axle hub).
- Wrap hydraulic fittings with anticorrosive wrap.
- Seal frame rail split.
- Use glad hand seals with dust flaps for air system.

7.5.4 Practical examples

The following are some practical examples of how fleet components were replaced or modified to prevent corrosion. Additional examples can be found in Appendix E.

Corrosion of electrical components is costly. In Figure 45, there is a relay and circuit breaker for spreader controls, mounted in the battery box. Specifications were revised to move these into an enclosed box inside the cab of the truck (Smith, 2014).



Figure 45. A relay and circuit breaker for spreader controls; mounted in the battery box (left), enclosed box inside the cab of the truck (right) (Smith, 2014).

Corrosion can lead to lighting repair in a DOT fleet. PennDOT worked closely with Whelan Engineering to develop specifications that placed the control module under the passenger seat. In Figure 46 individual “Home Run” cables are directly connected to every light head. This eliminates splices and hence location for corrosion to start. Deutsch connectors are specified at each light head to connect each cable. Costs associated with lighting and wiring repairs are greatly reduced. In the right picture, a newly adopted lighting package is shown (Smith, 2014).



Figure 46. New lighting control module under the passenger seat (left), newly adopted lighting package (right) (Smith, 2014).

Figure 47 shows the use of **Iowa type and direct cast spinners** (left), and **zero velocity spreaders** (right) “which have proven to reduce corrosion in the rear module area as compared to a standard under tailgate spreader/spinner assembly by keeping material contained. The additional benefit of these units is the improved material placement on the roadway” (Smith, 2014).



Figure 47. Iowa type and direct cast spinners (left), and zero velocity spreaders (right) (Smith, 2014).

Corrosion between dissimilar metals is a problem. This can be resolved by specifications requiring polyester film, plastic sheeting, or similar materials to be installed at any points of contact between dissimilar metals (Smith, 2014). Using oil pans made of stainless steel will allow for a specification with a 5 year warranty (Smith, 2014) (Figure 48).



Figure 48. Corroded oil pans (left), and replaced by stainless steel (right) (Smith, 2014).

As shown in Figure 49, a steel body is supported by a stainless steel stacked understructure. “Bodies are finished in a powder coat that offers a 12% investment in the purchase price while providing corrosion control” (Chupas, 2014).



Figure 49. Understructure of stainless steel (Chupas, 2014).

Figure 50 shows the application of Fluid Film, a corrosion control product originally designed for marine environments. ConnDOT tested Fluid Film during the winter of 2013/2014 with excellent results and they are considering expanding use of this product to include more of the fleet (Chupas, 2014).



Figure 50. Fluid Film applied to frame rails and undercarriage (Chupas, 2014; Fluid Film, 2014).

Connecticut DOT required as part of its specification for wheeled loaders that the vendor provide an Extended Corrosion Control system, to include hydraulic cooler, radiator, and all metal parts (Chupas, 2014). Caterpillar was awarded the contract and provided the system from Nyalic (Figure 51). ConnDOT has seen excellent results over the past three winters (Chupas, 2014).



Figure 51. ConnDOT Wheeled Loader from Caterpillar (Chupas, 2014).

Connecticut DOT has seen extensive corrosion of sanding chains that were requiring annual maintenance for the fleet (Chupas, 2014). Recently, ConnDOT worked with a company to develop an auger system tray that bolts into the current sanding chain area of the body (Figure 52). The goal of this modification is to reduce maintenance over the lifecycle of the truck.



Figure 52. ConnDOT auger system tray that bolts into the current sanding chain area of the body (Chupas, 2014).

Connecticut DOT has started purchasing western style understructure for tri-axle trucks (Figure 53). The benefit of using the Western understructure is a smooth floor with little area to collect salt and debris, which results in easier cleaning and reduced corrosion (Chupas, 2014).



Figure 53. Western style understructure tri axle trucks used by ConnDOT (Chupas, 2014).

7.5.5 Operational Methods to Mitigate Corrosion on Existing Equipment

Examples of equipment improvements, for winter maintenance trucks include (Shi et al., 2013; Mills, 2011 and 2012; NACE C-HC, 2014; OAVET, 2014):

- Protect new and replacement components prior to installation with wraps, cover, or shields.
- Open up closed areas (e.g. pillars) and allow them to flush out easily.
- Use welds to close and seal off certain areas that are difficult to drain.
- Caulk welds prior to painting.
- Maintain brake rust shield.
- Where possible, do the dehumidification and sheltering of the equipment.
- Use new primer and coatings technology, such as cathodic electrodeposition primer, antichip coatings, and clear coat paints.
- Inject polyurethane foam, as a post-design corrosion inhibition technique, to cavities.
- Apply underbody splash shields.
- Use resin sealers for insulating body joints and crevices.
- Keep mud flaps in good condition to protect against salt splash.
- Inspect brake shoes and linings, even new versions, regularly by removing brake drums and checking the entire lining surface and the brake shoe web, rollers, cam, etc.
- Repair the damaged spots on chassis paint as soon as possible.
- Avoid drilling of unnecessary holes, and paint edges where drilling has occurred.
- The repainting and recoating should be done by an expert using corrosion-resistant products.
- Wax polished aluminum and stainless steel appearance components.
- Reduce use of dissimilar metals and separate such components with insulation.
- Do not leave materials on board for extended periods.
- Eliminate the areas where solids and liquids may accumulate.
- Collaborate with maintenance crews and management to find and use effective application techniques that avoid over applications of salt or anti-icers.
- Before final acceptance of purchased vehicle, check for smooth edges and finishes without chips, pits, or gaps; and check electroplated surfaces for thin spots.

7.5.6 Maintenance Programs

The following steps can aid in establishing a successful corrosion management program:

- Make it an integral part of Fleet Management
- Take a life cycle perspective & holistic approach
- Manage the deicer-related corrosion risks at the program level
- Accountability includes records keeping and performance monitoring
- Develop anti-corrosion design guidelines and specifications
- Select materials & parts for corrosion prevention
- Include corrosion control requirements in purchase orders
- Prepare technical orders for corrosion-related maintenance

Other factors that should be considered when establishing a successful maintenance program include (Polard, 2013):

- Management, supervisors, and production planners must:
 - Support the maintenance effort with their attention and money. Most applicators cannot and will not perform the required maintenance tasks unless it is driven from the top down.
 - Allow for scheduled downtime. Scheduled downtime puts you in control of when maintenance is performed and increases productivity over time.
- Small repairs should be completed on the spot when possible, whereas large repairs should be scheduled as soon as the problem is identified and completed on time as scheduled.

Figure 54 provides a sample flow chart for a corrosion maintenance program (CPC, 2007).

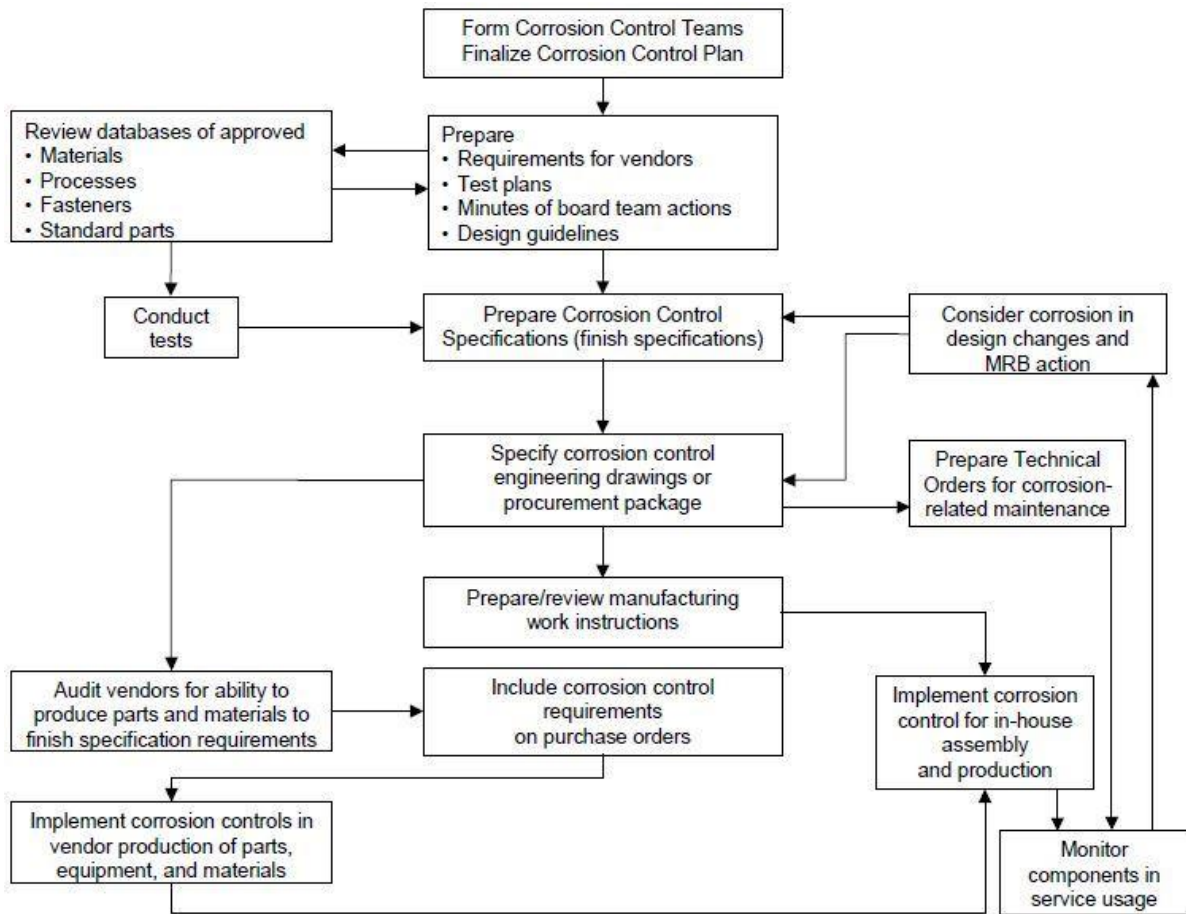

Figure 54. An example of a corrosion management program (CPC, 2007).

7.5.7 Recent progress and advancements

7.5.7.1 Washington State Department of Transportation (WSDOT)

PRP Industries entered into a corrosion test study with WSDOT. PRP Industries will perform a series of field studies using WSDOT plow trucks to identify cost effective solutions to corrosion problems on these vehicles (WSDOT & PRP, 2014). This study will help to identify solutions to corrosion on vehicle frames, fuel tanks, wheels, air valves, dump bodies and various other components. The test will be conducted on new trucks and components going into service and examples are shown in Figure 55, Figure 56, and Figure 57.



Figure 55. a & b) A new body treated with PRP CORSOL, then top coated with PRP Acrylic Urethane, c) a dump body after 5 years of use on a salt spreader truck (WSDOT & PRP, 2014).



Figure 56. Brake valves and glad hand treated with CORSOL prior to installation (WSDOT & PRP, 2014).

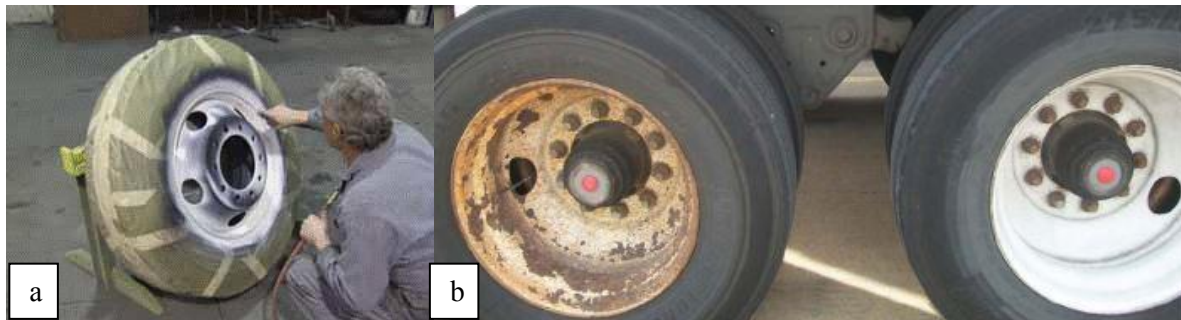

Figure 57. a) A new wheel is stripped of its coating, treated with CORSOL, then top coated with PRP Hybrid Urethane, b) trailer wheels after 6 years (left) and in field success of COROSOL after 6 years (right) (Courtesy of PRP industries; WSDOT & PRP, 2014).

7.5.7.2 Bus Bumpers

School bus customers were having corrosion problems on bumpers within a year of purchasing new equipment. The existing bumpers were washed and pre-treated with a 5 stage iron phosphate system, and then powder coated glossy black. As the solution, PRP developed a system utilizing the 5 stage wash system, but eliminating the iron phosphate, and introducing a wet coat primer and top coat. By modifying the treatment procedure, the high temperature powder bake ovens were eliminated from the process which resulted in reduced energy costs. Testing of busses with this new treatment ran for two years at the Ford Motor Company Arizona Proving Grounds. The test simulated 25 years of exposure and related corrosion (Figure 58 & Figure 59). The benefits of this coating include utilization of the existing wash system, elimination of iron phosphate, a dramatic increase in corrosion protection, and the elimination of costly ovens (PRP, 2014).

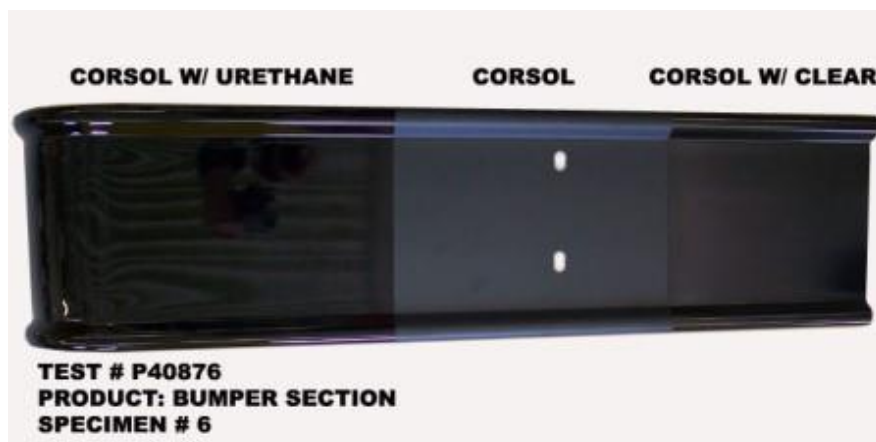

Figure 58. A section of a bumper treated with PRP Corsol Metal Treatment System showing the bumper treatment test design (PRP, 2014).



Figure 59. a) 60 APG cycles, b) 100 APG cycles, c & d) 150 APG cycles of Corsol system compared (left) to standard powder coat (right) (PRP, 2014).

7.5.7.3 Gas Cylinders

Gas cylinders that were being sent offshore were corroding within a year. The corrosion caused pitting of the steel, which reduced the service life of the gas cylinders. A Corsol Metal Treatment System was applied to mitigate the corrosion problem (Figure 60). This same treatment technique has been used to successfully protect the fuel tanks (PRP, 2014).



Figure 60. The standard cylinder group on top compared to the PRP treated cylinders on the bottom (PRP, 2014).

Chapter 8: Training and Facility Management

8.1. Operator Training

Operators typically are trained on the fundamentals of plowing and spreading, but less frequently are they trained how the materials work and what their effects are. For example, most operators know that salt melts snow or ice but are unaware that it does not function below a certain temperature, or that a lot of salt is no more effective in certain conditions than lesser amounts.

Operators, including contractors, need to know the basic characteristics of each product being used, including inert abrasives. These factors include: effective temperature range, corrosiveness, toxicity, environmental impacts, recommended application rates, and special handling precautions. For example, mixing calcium chloride with some organic-based anti-icers may result in clogged sprayers.

In addition to a basic understanding of plowing and spreading, supervisors and managers need a deeper understanding of the capabilities and drawbacks of each substance that will be used in order to make informed decisions under changing conditions. For instance, should brines be applied in advance of a storm when rain will precede the snow? Should certain chemicals be used if temperatures are expected to rise?

8.2. Mechanic Training

Mechanics who repair and maintain the fleet need basic information on the materials used and the associated characteristics, especially an understanding of the corrosiveness of each chemical. This will help mechanics identify potential locations on the vehicles susceptible to corrosion and what preventive measures can be taken.

8.3. Management Responsibilities

Supervisors and managers are responsible for making sure that operators and mechanics and others involved in transporting, handling, and storing materials have the proper training. It is also their responsibility to ensure compliance with the established policies and practices both at the facilities and in the field. Lastly, supervisors and managers need to be able to cogently explain not only to staff but to upper jurisdictional leadership, the media and the public why, how, and when materials are used.

8.4. Facilities

“Good housekeeping” should be an everyday standard at any agency facility where materials are stored and handled. Bulk rock salt should be kept under weather-secure cover and structures should be regularly checked for leaks. Not only does rain water on a salt pile create a brine runoff, it will also cause the pile to harden into large masses that are difficult to break up. All runoff from a salt or sand/salt mix pile must be diverted into a detention structure and not allowed to flow into surface water bodies or onto permeable ground or sewers, unless permits with location water municipalities are in place.

Liquid anti-icing chemicals must be stored in either underground or, more commonly, above ground tanks surrounded by secondary containment structures to capture leaks and spills. The dispensing apparatus needs to be frequently checked for leaks, cracks, and operability. Tank levels should also be checked on a regular schedule, especially during the off-season to detect sedimentation, leakage, or in the case of organics, buildup of bacteria.

After every storm when materials are used, the travel and parking areas of the grounds need to be cleaned of loose salt and abrasives usually by mechanical sweepers, and hand brooms and shovels. Public Works and DOT yards typically store metal pipes, poles, and rails that are used for other infrastructure maintenance. As much as is possible these items should be placed on racks, stands or bolsters that keep them off the ground to avoid exposure to snow melt that carries diluted salts. Floor surfaces of facilities need to be cleaned post-storm, including garage areas.

References

- Abelson P. The Benefits of Preventive Maintenance. <http://www.theconcreteproducer.com/fleets-trucks-and-accessories/the-benefits-of-preventive-maintenance.aspx>, accessed in August 2014.
- Agarwala, V.S. "Control of Corrosion and Service Life." CORROSION 2004, NACE-04257, 28 March-1 April, New Orleans, Louisiana.
- AFRC, Air Force Corrosion Prevention and Control Office. Corrosion prevention and control survey of AFRC, Final HQ AFRC Report, 2003.
- Aluminum Association, Inc. "Aluminum: The Corrosion Resistant Automotive Material." 2001.
- Amrhein, C., Strong, J. E. and Mosher, P. A., Environm. Sci. Tech., 26(4) (1992), 703-709.
- Amtec Corrosion And Coatings Consultants. <http://www.amteccorrosion.co.uk/coatingsguide.html>, accessed in August 2014.
- ASCA, Accredited Snow Contractors Association. <http://www.ascaonline.org/snow-033012-voiding-snowplow-breakdowns.aspx#.VCGzXqHnbTM>, accessed in September 2014.
- ASTM International, Designation: D523 – 14: Standard Test Method for Specular Gloss, 2014.
- ASTM International, Designation: D610 – 08 (Reapproved 2012): Standard Practice for Evaluating Degree of Rusting on Painted Steel Surfaces, 2012.
- ASTM International, Designation: D714 – 02 (Reapproved 2009): Standard Test Method for Evaluating Degree of Blistering of Paints, 2009.
- ASTM International, Designation: D1654 – 08: Standard Test Method for Evaluation of Painted or Coated Specimens Subjected to Corrosive Environments, 2008.
- ASTM International, Designation: D2244 – 11: Standard Practice for Calculation of Color Tolerances and Color Differences from Instrumentally Measured Color Coordinates, 2011.
- Ault, P.J. "Corrosion Durability Testing of Military Vehicles." Metal Finishing, 1999.
- Ayebah, B., Efficiency of Electrolyzed Water as a Sanitizer and Cleaning Agent and its Effect on Food Contact Surfaces, PhD thesis, University of Georgia, USA, 2006.
- Ayello, F., Hill, D., Marion, S., Sridhar, N. "Integrated Sensor Networks for Corrosion Under Insulation: Monitoring, Cost Reduction, and Life Extension Strategies." CORROSION 2011, NACE-11281, 13-17 March, Houston, Texas.

Baldi, A. L., Crombie, E. A., Dillard, D. P., Handsy, I. C. "Development of a Computerized Data Base to Monitor Wheeled Vehicle Corrosion." Research, Development and Engineering Center Technical Report, 1989.

Barrero, C.A., Ocampo, L.M., Arroyave, C.E. "Possible improvements in the action of some rust converters." Corrosion Science, 2001, 43, 1003-1018.

Light Truck Frame Project Team, Auto/Steel Partnership. "A Guide to Corrosion Protection for Passenger Car and Light Truck Underbody Structural Components.", 1999.

Bierwagen, G.P., He, L., Li, J., Ellingson, L., Tallman, D.E. "Studies of a New Accelerated Evaluation Method for Coating Corrosion Resistance- Thermal Cycling Testing." Progress in Organic Coatings, 2000, 39, 67-78.

Boeing (The Boeing Company), Aero 07 - Design for Corrosion, http://www.boeing.com/commercial/aeromagazine/aero_07/corrosn.html, accessed in June 2014.

Bolivar, F., Barrero, C.A., Minotas, J., Morales, A.L., Greneche, J.M. "Variable Temperature Mossbauer Study of Some Rust Converters." Hyperfine Interactions, 2003, 148/149, 219-225.

Bosich, J. F., Corrosion prevention for practicing engineers, Barnes & Noble, 1st ed., 1970.

BTI Products, Specialists in Microbiologically Influenced Corrosion (MIC), <http://www.bti-labs.com/>, accessed in January 2014.

Bucher, W.W. and Madrid, C. Dictionary of Building Preservation. New York: Wiley Interscience. ISBN 0-471-14413-4. 1996.

Buckler D.R. and Granato, G.E., Assessing biological effects from highway runoff constituents. U.S. Department of the Interior and U.S. Geological Survey, Open-File Report 99-240, 2002.

Caseres, L. "Evaluation of Zn-rich Primers and Rust Converters for Corrosion Protection of Steel." U.S. Army Corrosion Summit Clearwater Beach, FL, 2009, 1-22.

Chappelow, C.C., McElroy, A.D., Blackburn, R.R., Darwin, D., de Noyelles, F.G., Locke, C.E. "Handbook of Test Methods for Evaluating Chemical Deicers." Strategic Highway Research Program Report No. 332 (SHRP H-205.7) National Research Council, 1992.

Chupas, J. Connecticut Department of Transportation (ConnDOT). "Corrosion Prevention Methods." a presentation at Transportation Research Board (TRB) 93rd Annual Meeting, January 12-16, 2014, https://pavementvideo.s3.amazonaws.com/2014_Nat_Equip/PDF/22%20-%20Corrosion%20Prevention%20Methods%20-%20Chupas.pdf, accessed in August 2014.

Clonch, D. Vehicle & Equipment Cleaning: Fighting Corrosion from Chemical Deicers. 17th Annual Snow & Ice Symposium, June 18-21, 2014, Columbus, OH, <http://www.sima.org/docs/default-source/default-document-library/equipment-cleaning.pdf?sfvrsn=0>, accessed in September 2014.

Collazo, A., Novoa, X.R., Perez, C., Puga, B. "EIS study of the rust converter effectiveness under different conditions." *Electrochimica Acta*, 2008, 53, 7565-7574.

Collazo, A., Novoa, X.R., Perez, C., Puga, B. "The corrosion protection mechanism of rust converters: An electrochemical impedance spectroscopy study." *Electrochimica Acta*, 2010, 55, 6156-6162.

Cornwell, M. "Michigan Road Salts: What Is It Costing Us." *Michigan Science*, 16, 7-8, 2011.

CPC, Corrosion Prevention and Control Planning Guidebook. Spiral 3. U.S., Department of Defense, September 2007, http://www.google.com/url?sa=t&rct=j&q=&esrc=s&frm=1&source=web&cd=1&cad=rja&uact=8&ved=0CB4QFjAA&url=http%3A%2F%2Fwww.dtic.mil%2Fcgi-bin%2FGetTRDoc%3FAD%3DADA473723%26Location%3DU2%26doc%3DGetTRDoc.pdf&ei=vnACVPPDKYvnoASn7YD4Dw&usq=AFQjCNF_mDujm5vaZIf-9vi8IPfluZOdgA&bvm=bv.74115972,d.cGU, accessed in August 2014.

CPC, Corrosion Prevention and Control Planning Guidebook for Military Systems and Equipment. Office of DoD Corrosion Policy and Oversight Spiral: 4 Release Date: 2/4/2014, http://corrdefense.nace.org/corrdefense_Spring2014/CPCguidebook.pdf, accessed in August 2014.

Dante, J., Price, K., Sabata, A., Sabata, B. "Embedded Coating Degradation Sensors for Monitoring Performance of Temporary Coatings." NACE International Corrosion Conference Paper # 07387, 2007.

Davis, G. D., Dacres, C. M., Krebs, L. A. "EIS-Based In-Situ Sensor for the Early Detection of Coatings Degradation and Substrate Corrosion." NACE International Corrosion Conference Paper # 000275, 2000.

Davis, J. R., *Surface Engineering for Corrosion and Wear Resistance*, ASM International, 1st ed., 2001.

DC Fire and EMS, District of Columbia Fire and Emergency Medical Services Department. <http://www.tommywellward6.com/FEMS%20Apparatus%20Division%20-%20Audit%20%20%20and%20Assessment%20Report%20FINAL%20112513%20--%20Double-sided%20printing.pdf>, accessed in August 2014.

Demo, J., Steiner, A., Friedersdorf, F., Putic, M. "Development of a Wireless Miniaturized Smart Sensor Network for Aircraft Corrosion Monitoring." IEEAC paper # 1107, 2009.

Eck. http://www.eckcorrosion.com/uploads/PPG_Minimizing-the-Effects-of-Corrosion.pdf, accessed in September 2014.

El-Meligi, A.A. "Corrosion Preventive Strategies as a Crucial Need for Decreasing Environmental Pollution and Saving Economics." *Recent Patents on Corrosion Science* 2, 2010, 22-33.

Engineering Dictionary. [http://www.engineering-dictionary.org/CORROSION,_DEPOSIT_\(also_called_poultice_corrosion\)](http://www.engineering-dictionary.org/CORROSION,_DEPOSIT_(also_called_poultice_corrosion)), accessed in December 2014.

Fay, L. and Shi, X. 2012. Environmental Impacts of Chemicals for Snow and Ice Control: State of the Knowledge. Water, Air & Soil Pollution. <http://www.springerlink.com/content/n1451658mky72964/>

Fay, L., Volkening, K., Gallaway, C. and Shi X., in Proceedings (DVD-ROM) of the 87th Annual Meeting of Transportation Research Board (held in Washington D.C., January 2008), eds. Transportation Research Board, Paper No. 08-1382, 2008.

FHWA, Federal Highway Administration. Corrosion costs and preventive strategies in the United States. Publication No. FHWA-RD-01-156, 2002.

FHWA, Federal Highway Administration. <https://www.fhwa.dot.gov/policy/2004cpr/chap3d.htm>, accessed in August 2014.

Fluid Film, <http://www.fluid-film.com/spraying/>, accessed in September 2014.

Frakes, J. The 411 on SurfacePrep: An Important Component of the Coatings Process. CoatingsPro Magazine: SurfacePrep Supplement. NACE International, March 2014, 4-9.

Gadag, R. V., Ntyananda Shetty, A., Engineering Chemistry, I. K. International Publishing House, 1st ed., 2006.

Garosshen, T. J., Mukherji, T. K. “On the Correlation of Bimetallic Corrosion Sensor Output to Actual Corrosion Damage.” NACE International Corrosion Conference Paper # 00266, 2000.

Gavrila, M., Millet, J.P., Mazille, H., Marchandise, D., Cuntz, J.M. “Corrosion behavior of zinc-nickel coatings, electrodeposited on steel.” Surface and Coatings Technology 2000, 123, 164-172.

GM Techlink, <http://www.archivedsites.com/techlink/2009/08/gm-techlink---august-2009.html>, accessed in August 2014.

Gooch, J. W. and Daher, J. K., Electromagnetic Shielding and Corrosion Protection for Aerospace Vehicles, Springer, 2007, 1st ed.

Granata, R. D. “Nonmetallic Coatings.” Corrosion Tests and Standards: Application and Interpretation-Second Edition, 2005, 632-636.

Hartley, A.R. and Wood, D.H. CORROSION RESISTANCE OF INDUSTRIAL BRINE SOLUTIONS, US Patent 2009/0169422 A1, 2009.

Hartley, P. “Corrosion Protection.” Fleet Equipment, 16-18, 2010.

Huttunen-Saarivirta, E., Kuokkala, V.T., Kokkonen, J., Paajanen, H. “Corrosion behavior of aircraft coating systems in acetate-and formate-based de-icing chemicals” Materials and Corrosion, 2009, 60 (3), 173-191.

Jakab, M. A., Tormoen, G. W., Dante, J. F. “Measurement of CPC Performance Using EIS Based Sensor Methods- Laboratory and Field Studies.” CORROSION 2008, NACE-08202, 28 March-1 April, New Orleans, Louisiana..

Johnson, J. T., Corrosion costs of motor vehicles, 2002. <http://www.corrosioncost.com/pdf/transportation.pdf>, accessed in July 2007.

Jones, D. A. Principles and Prevention of Corrosion. 2nd Ed. New Jersey: Prentice Hall, 1996.

Kane, R. D., Eden, D. C., Eden, D. A. “Real-Time Solutions Integrate Corrosion Monitoring with Process Control.” Materials Performance, 2005, 36-41.

Kinzie, R. C. “Measuring the Rates and Impact of Corrosion Damage.” Aircraft Engineering and aerospace Technology, 2003, 75 (2), 123-129.

Koch, M. Coating Requirements & Projects for USMC Vehicles. ASETSDefense 2011, 08 February 2011. http://www.asetdefense.org/documents/Workshops/SustainableSurfaceEngineering2011/20-Koch%202011_ASETS_PresentationTue_aft.pdf, accessed in September 2014.

Koch, M. U.S. Marine Corps Corrosion Prevention and Control (CPAC) Program Overview. Town and Country Resort & Convention Center, San Diego, CA. June 7-10, 2010. https://www.navalengineers.org/SiteCollectionDocuments/2010%20Proceedings%20Documents/Mega%20Rust%202010%20Proceedings/Tuesday/MR2_Koch.pdf, accessed in September 2014.

Koch, M. and Friend, B. U.S. Marine Corps Corrosion Prevention and Control (CPAC) Program Status. 2009 U.S. Army Corrosion Summit, 3-5 Feb, Clearwater Beach, FL. <http://www.google.com/url?sa=t&ret=j&q=&esrc=s&firm=1&source=web&cd=3&cad=rja&uact=8&ved=0CC0QFjAC&url=http%3A%2F%2Fwww.dtic.mil%2Fcgi-bin%2FGetTRDoc%3FAD%3DADA508954&ei=zuslVPntI5ProAStzYGoBw&usq=AFQjCNH6db1NZv8fhha9iOpEZH3CwZDw5g&sig2=eF1cG36PEf7DyWPcfg7WfQ&bvm=bv.76247554.d.cGU>, accessed in January 2014.

Koefod, R. S., CORROSION-INHIBITING DEICER COMPOSITION, US Patent 7658861 B2, 2010.

Kopeliovich, D., http://www.substech.com/dokuwiki/doku.php?id=galvanic_corrosion&do=show, accessed in May 2009.

Kruger, J. “Passivity,” Ch. 9, pp. 165-172, in Uhlig’s Corrosion Handbook, 2nd Edition, Ed. R. W. Revie, John Wiley & Sons, New York, NY, 2000.

KSC Corrosion Technology Laboratory Home – Nasa. http://corrosion.ksc.nasa.gov/corr_forms.htm, accessed in August 2014.

Kuznetsov, Y.I., “Current State of the Theory of Metal Corrosion Inhibition.” Protection of Metals, 2002, 38 (2), 103-111.

Lee, C.C. and Mansfeld, F. “Automatic classification of polymer coating quality using artificial neural networks.” Corrosion Science, 1999, 41, 328-350.

Leidheiser Jr., H. “Electrochemical Methods for Appraising Corrosion Protective Coatings.” The Journal of Coatings Technology, 1991, 63, 21-31.

Levelton Consultants Ltd. Guidelines for the selection of snow and ice control materials to mitigate environmental impacts. NCHRP Report 577. National Cooperative Highway Research Program, National Research Council, Washington, D.C., 2008. http://onlinepubs.trb.org/onlinepubs/nchrp/nchrp_rpt_577.pdf, accessed in July 2008.

Libowitz, G. G., Whittingham, M. S., Materials Science in Energy Technology, 1979, 1st ed.

Lockridge, D. The Monster That's Eating Your Rigs. TruckingInfo.com, November 2007, accessed in August 2014.

Meyer Drive Pro. Operation and Maintenance Manual. 2008. <http://www.meyerproducts.com/portals/0/meyer/pdfs/ownersmanuals/4-547r-drive-pro.pdf>, accessed in September 2014.

Mills, M. Corrosion to Snow & Ice Material Application Equipment. Western Snow & Ice Conference 2012, http://www.google.com/url?sa=t&rct=j&q=&esrc=s&frm=1&source=web&cd=1&cad=rja&uact=8&ved=0CB4QFjAA&url=http%3A%2F%2Fwww.westernsnowandice.com%2F2012presos%2FMontyMillsPresentation.ppt&ei=d30pVLSXM8SujAKrjYCYCw&usq=AFQjCNHjXAJ8L6KW5WB6As0oUmuMYyZGiW&sig2=KKu9r8a3U_In11IUcaGWqw&bvm=bv.76247554,d.cGE, accessed in September 2014.

Mills, M. Corrosion to Snow & Ice Material Application Equipment, The Western States Highway Equipment Managers Association (WSHEMA) Conference 2011, http://www.wshema.com/2011_presentations/WA/Corrosion%20to%20Snow%20&%20Ice%20Material%20Application%20Equipment%20V%20-2%20.pdf, accessed in February 2014.

Monty, C., Miller, M.C., Schneider IV, W.H., Rodriguez, A. Evaluation of the Effectiveness of Salt Neutralizers for Washing Snow and Ice Equipment. Final report prepared for the The Ohio Department of Transportation, Office of Statewide Planning & Research. February 2014, http://www.dot.state.oh.us/Divisions/Planning/SPR/Research/reportsandplans/Reports/2014/Materials/134718_FR.pdf, accessed in April 2014.

MP, Materials Performance. Protective Coatings Selection and Application. November 2005, p. 50.

NACE C-HC, NACE International, Community - Household Corrosion, <http://events.nace.org/library/community/household/auto.asp>, accessed in January 2014.

NACE CF, NACE International, Corrosion Fatigue (NACE CF), <http://www.nace.org/Corrosion-Central/Corrosion-101/Corrosion-Fatigue/>, accessed in September 2014.

NACE GA, NACE International, General Attack, <http://www.nace.org/General-Attack-Corrosion/>, accessed in January 2014.

NACE MR0175/ISO15156, Petroleum and natural gas industries—Materials for use in H₂S-containing Environments in oil and gas production. NACE International/ISO 2001.

Narmada, P., Venkateswara Rao, M., Venkatachari, G., Appa Rao, B.V. “Synergistic Inhibition of Carbon Steel by Tertiary Butyl Phosphonate, Zinc Ions and Citrate.” *Anti-Corrosion Methods and Materials*, 2006, 53 (5), 310-314.

NASA-KSC TM-584C. Corrosion Control and Treatment Manual, November 1, 1994, <http://corrosion.ksc.nasa.gov/pubs/tm584c.pdf>, accessed in January 2014.

National Research Council. Erosion Control in Energy Systems, National Materials Advisory Board, 1977.

Nixon, W. A. and Xiong, J. Investigation of Materials for the Reduction and Prevention of Corrosion on Highway Maintenance Equipment. Iowa Highway Research Board. IIHR Technical Report # 472. May 2009.

NPL, National Physical Laboratory. Corrosion Control in Engineering Design, 2000, http://www.npl.co.uk/upload/pdf/corrosion_control_in_engineering_design.pdf, accessed in June 2014.

OAVET. Wheels in Winter Preventing Corrosion. <http://www.oaevt.org/Corrosion.pdf>, accessed in August 2014.

Ok, D., The Effects of Corrosions and Fatigue Induced Cracks on Strength Degradation in Ageing Ships, PhD thesis, Newcastle University, United Kingdom, 2006.

Oliver, D.C., Sephton, M. “External Corrosion Resistance of Steel and Ferritic Stainless Steel Exhaust Systems.” *The Journal of the South African Institute of Mining and Metallurgy*, 2003, 93-100.

Osborne, J., Krienke, K., DeAntoni, J., Kendig, M., Hon, M., Teachout, L., Ray, C. and Kovaleski, K. Progress in the Development of a Self-Priming Topcoat with Enhanced Weatherability and Corrosion Protection. Tri-Service Corrosion Conference 2003, Las Vegas, Nevada.

Palmer, J.D. Current Public Interest Aspect of Automotive Corrosion. Proceedings of the CORROSION/91 Symposium “Automotive Corrosion and Protection”. Editor: Robert Baboian. Published by NACE. Houston, TX, 1992.

Papavinasam, S., Corrosion Control in the Oil and Gas Industry, Gulf Professional Publishing, 1st ed., 2014.

Payer, J.H.. Effect of Environmental Stress on Reliability of Automotive Electronics. Proceedings of the CORROSION/91 Symposium “Automotive Corrosion and Protection”. Editor: Robert Baboian. Published by NACE. Houston, TX, 1992.

Peters, H., “Cost Effective Chemical Removal of Corrosion Inducing Surface Salts.” Tri-Service Corrosion Conference 2003, Las Vegas, Nevada.

Phan, N.D. "P-3 SERVICE LIFE ASSESSMENT PROGRAM (SLAP) – A HOLISTIC APPROACH TO INVENTORY SUSTAINMENT FOR LEGACY AIRCRAFT." Tri-Service Corrosion Conference 2003, Las Vegas, Nevada.

Phelps, J. The Snowplow Blogger: 6 Tips to Protect Your Snowplow From Corrosion, July 2013. <http://info.bosspow.com/Blog/bid/150042/6-Tips-to-Protect-Your-Snowplow-From-Corrosion>, accessed in September 2014.

Polard, J. Hustle and Flow: A Preventive Equipment Maintenance Strategy. CoatingsPro Magazine. NACE International, September 2013, 38-40.

PRP industries, <http://www.prpindustries.com/case-studies>, accessed in September 2014.

Reboul, M. C., Baroux, B., "Metallurgical Aspects of Corrosion Resistance of Aluminum Alloys." Materials and Corrosion 2011, 62, (3).

Resene, ECS - 1:3 Design principles for corrosion prevention, http://www.resene.com/archspec/datasheets/ECS1_3DesignPrinciples.pdf, accessed in June 2014.

Revie, R. W., Uhlig's Corrosion Handbook, John Wiley and Sons, 3rd ed., 2011.

Roberge, P. R., Handbook of Corrosion Engineering, McGraw-Hill, 1999, 1st ed.

Rust Bullet, Introduction to Corrosion and Process, <http://www.rustbullet.com.au/technical/how-it-works/introduction-to-corrosion-and-process/>, accessed in September 2014.

Salt Institute, <http://www.saltinstitute.org/33>, accessed in October 2008.

Schlesinger, M. and Paunovic, M. Modern Electroplating, John Wiley and Sons, 1st ed., 2010.

Schmidt, D.P., Shaw, B.A. Sikora, E., Shaw, W.W., Laliberte, L.H. "Comparison of Testing Techniques Used to Analyze the Corrosion Resistance of Sacrificial Coating Systems." Corrosion, 2007, 63(10), 960-976.

Schmidt, D.P., Shaw, B.A., Sikora, E., Shaw, W.W., Laliberte, L.H. "Corrosion protection assessment of sacrificial coating systems as a function of exposure time in a marine environment." Progress in Organic Coatings 2006, 57, 352-364.

Sharman, S. "Evaluation & Performance of Chemical Surface Treatments for Maintenance." NACE International Corrosion Conference and Expo Paper # 09006, 2009.

Sheffer, M., Groysman, A., Mandler, D. "Electrodeposition of sol-gel films on AL for corrosion protection." Corrosion Science, 2003, 45, 2893-2904.

Shi, X., Best Practices for Preventing and Mitigating Corrosion of Metals in Maintenance Equipment: A Cold-Climate Perspective. A Presentation at 2014 National Conference on Equipment Fleet Management, Orlando, FL, June 10, 2014, <http://ine.uaf.edu/cesticc/docs/DeicerCorrosion.pdf>.

Shi, X., in Proceedings of the ITE District 6 Annual Meeting (held in Kalispell, Montana, July 10-13, 2005), eds. Institute of Transportation Engineers, 2005.

Shi, X.; Avci, R.; Geiser, M. and Lewandowski, Z., Comparative study in chemistry of microbially and electrochemically induced pitting of 316L stainless steel, *Corrosion Science* 45 (2003) 2577–2595.

Shi, X., Hansen, G., Mills, M., Jungwirth, S., Zhang, Y. Preserving the Value of Highway Maintenance Equipment against Roadway Deicers: A Case Study and Preliminary Cost Benefit Analysis. *Anti-Corrosion Methods and Materials*, 2015, in review.

Shi, X., Li, Y., Jungwirth, S., Fang, Y., Seeley, N., Jackson, E. Identification and Laboratory Assessment of Best Practices to Protect DOT Equipment from the Corrosive Effect of Chemical Deicers. Final report prepared for the Washington State Department of Transportation. March 2013, <http://www.wsdot.wa.gov/research/reports/fullreports/796.1.pdf>, accessed in January 2014.

Shi, X., Xie, N. and Gong J. (2011). “Recent Progress in the Research on Microbially Influenced Corrosion: A Bird’s Eye View through the Engineering Lens”. *Recent Patents on Corrosion Science*, 2011, 1, 118-131.

Shreir, L.L., Burstein, G.T., Jarman, R.A., *Corrosion*, Volumes 1-2, 1994, 3rd ed., Butterworth-Heinemann.

Sitaram, S.P., Stoffer, J.O., O’Keefe, T.J. “Application of Conducting Polymers in Corrosion Protection.” *Journal of Coatings Technology* 1997, 69, 65-69.

Smith, W.J. “Corrosion Preventative Best Practices.” a presentation at Transportation Research Board (TRB) 93rd Annual Meeting, January 12-16, 2014.

SOW, P-3C SERVICE LIFE ASSESSMENT PROGRAM (SLAP); Phases II and III. Revision G, dated 28 October 1998, <http://fas.org/man/dod-101/sys/ac/docs/Sowa03.pdf>, accessed in March 2014.

Stephens, E., Pitman, S., Mattlin, K., Chamberlin, C., Dahl, M. “Effects of Highway Ice-Clearing Treatments on Corrosion of Heavy Vehicle Materials and Components”. A presentation by Pacific Northwest National Laboratory for the Pacific Northwest Snowfighters Conference, June 15, 2006. PNNL-SA-50448.

Sun, X., “Online Monitoring of Undercoating Corrosion Using Coupled Multielectrode Sensors.” *Materials Performance*, 2005, 28-32.

Tan, Y.-J. “Experimental methods designed for measuring corrosion in highly resistive and inhomogeneous media.” *Corrosion Science*, 2011, 53, 1145-1155.

Tan, Y.-J. “Measuring Electrochemical Noise Resistance from a Wire Beam Electrode Surface for Corrosion Rate and Pattern Determination.” *Fluctuation and Noise Letters*, 2003, 3(4), L419-L432.

Tan, Y.-J., Bailey, S., Kinsella, B. “Mapping non-uniform corrosion using the wire beam electrode method. II. Crevice corrosion and crevice corrosion exemption.” *Corrosion Science*, 2001, 43, 1919-1929.

Tan, Y.-J. “Wire Beam Electrode: A New Tool for Studying Localized Corrosion and Other Heterogeneous Electrochemical Processes.” *Corrosion Science*, 1998, 41, 229-247.

Tan, Y.-J. and Liu, T. “Inhibiting Localized Corrosion of Aluminum and Aluminum Alloy by Rare Earth Metal Compounds: Behaviors and Characteristics Observed Using an Electrochemically Integrated Multi-Electrode Array.” *Journal of the Electrochemical Society*, 2013, 160(4), C147-C158.

The Rust Store. Rust Prevention and Removal Specialists. <http://www.theruststore.com/Rust-FAQs-W51C2.aspx>, accessed in September 2014.

Thompson, N. G., Yunovich, M., Dunmire, D. “Cost of Corrosion and Corrosion Maintenance Strategies.” *Corrosion Reviews*, 25 (3-4), 247-261, 2007.

Totten, G.E., Wills, D.K. and Feldmann, D.G., *Hydraulic Failure Analysis: Fluids, Components, and System Effects*, American Society for Testing and Materials (ASTM), Issue 1339, 2001.

TRB, Transportation Research Board. *Highway Deicing: Comparing Salt and Calcium Magnesium Acetate*, Special Report 235.

UC Davis ChemWiki.

http://chemwiki.ucdavis.edu/Physical_Chemistry/Physical_Properties_of_Matter/Bulk_Properties/Cohesive_And_Adhesive_Forces/Contact_Angles, accessed in May 2014.

Uchida, M., Mochizuki, K., “Corrosion Behavior of Vehicles Operated in North America for 5 Years.” *Kawasaki Steel Giho*, 2000, 32 (1), 26-31.

US GAO, United States Government Accountability Office, *DEFENSE MANAGEMENT: DOD Should Enhance Oversight of Equipment-Related Corrosion Projects*, September 2013, <http://www.gao.gov/assets/660/657498.pdf>, accessed in January 2014.

Vitaliano, D. Remove suggestion. *J. Policy Anal. Mgmt.* 11(3) (1992), 397-418.

Walkabout Production Group, <http://longlonghoneymoon.com/2012/10/video-thor-stickectomy/> accessed in January 2014.

Weng, Y. “New Sensors of Wire Beam Electrodes (WBE) to Detect Pitting Sensitivity of Steels.” *Corrosion*, 2004.

WTI, Western Transportation Institute. *Preliminary Corrosion Investigation for Bill Field Trucking Company: Is Deicer the Culprit?* Internal email communications. Montana State University. Bozeman, MT, 2005.

WSDOT, Washington State Department of Transportation. *Equipment Corrosion*. APWA & PNS North American Snow Conference, April 2011.

WSDOT & PRP to perform corrosion testing. <http://www.prpindustries.com/news/204-wsdot-prp-to-perform-corrosion-testing>, accessed in September 2014.

Xi, Y. and Xie, Z. "Corrosion Effects of Magnesium Chloride and Sodium Chloride on Automobile Components." Colorado Department of Transportation Research Branch Report #CDOT-DTD-R-2002-4, 2002.

Yang, L., Sridhar, N., Brossia, C. S., Dunn, D. S. "Evaluation of the Coupled Multielectrode Array Sensor as a Real-Time Corrosion Monitor." Corrosion Science, 2005, 47, 1794-1809.

Zamanzadeh, M.; Larkin, E. and Gibbon, D. A Re-Examination of Failure Analysis and Root Cause Determination, MATCO Associates, 2005, www.matcoinc.com, accessed in February 2014.

Appendix A: Lists of Figures and Tables

List of Figures

Figure 1. General corrosion (Courtesy of MnDOT and Roberge, 1999).	3
Figure 2. Pitting corrosion (Kopeliovich, 2009; Courtesy of MnDOT and Roberge, 1999).	5
Figure 3. Crevice corrosion (KSC, 2014; Roberge, 1999).	5
Figure 4. Filiform corrosion (Walkabout Production, 2014; Courtesy of MnDOT and Roberge, 1999).	6
Figure 5. Intergranular corrosion (KSC, 2014, Kopeliovich, 2009 and Roberge, 1999).	7
Figure 6. Galvanic corrosion (Courtesy of MnDOT and Roberge, 1999).	8
Figure 7. Stress corrosion cracking (Kopeliovich, 2009 and Roberge, 1999).	9
Figure 8. Corrosion fatigue (Courtesy of MnDOT and Roberge, 1999).	9
Figure 9. An example of corrosion fatigue due to the stresses created by buildup of crevice corrosion products inside the lap joints followed by cyclic loading (KSC, 2014 and Roberge, 1999).	10
Figure 10. Rust Jacking (Abelson, 2014; Amtec Corrosion and Coatings Consultants, 2014).	10
Figure 11. Erosion corrosion (Kopeliovich, 2009; Roberge, 1999).	11
Figure 12. Fretting corrosion (GM Techlink, 2014; Roberge, 1999; and courtesy of MnDOT).	12
Figure 13. Microbially influenced corrosion (MIC) (BTI, 2014).	13
Figure 14. Selective attack of grain boundary on aluminum exposed to chloride-based deicers (Stephens, 2006).	14
Figure 15. Allocation of corrosion-related repair costs among WSDOT equipment (Shi et al., 2014).	15
Figure 16. Corrosion on snow and ice equipment (Monty et al., 2014).	16
Figure 17. Images of salt-related damage on brake drum and exhaust system (Shi, 2014).	16
Figure 18. Image of salt-related vehicle damage (Mills, 2011 and 2012).	17
Figure 19. Images of corrosion damages on PennDOT vehicles (Smith, 2014).	17
Figure 20. Images of vehicle corrosion damage taken by PRP Industries (PRP, 2014).	18
Figure 21. Images of corrosion damage on (Michigan DOT vehicles courtesy of MDOT).	19

Figure 22. Images of corrosion damage on NYSDOT vehicles (courtesy of NYSDOT).....	20
Figure 23. Images of corrosion damages on NDDOT vehicles (courtesy of NDDOT).....	21
Figure 24. Images of corrosion damages on RIDOT vehicles (courtesy of RIDOT).	22
Figure 25. Images of corrosion damages on VAOT vehicles (courtesy of VAOT).....	23
Figure 26. Images of damages due to corrosion on VAOT vehicles (courtesy of VAOT).....	25
Figure 27. Images of corrosion damages on ConnDOT vehicles (Chupas, 2014).....	27
Figure 28. A study of exhaust systems exposed to de-icing salts (Oliver, 2003).	35
Figure 29. Wide extrusion mechanical property comparison (Phan, 2003).....	36
Figure 30. Exfoliation Corrosion Test (ASTM G34) (Phan, 2003).	36
Figure 31. How to make proper holes in horizontal diaphragms (Roberge, 1999).....	38
Figure 32. How to prevent water traps (Roberge, 1999).....	38
Figure 33. How to insulate two disimilar metals against galvanic corrosion (Roberge, 1999).	39
Figure 34. Schematic of some appropriate designs (Aluminum Association, 2001).	40
Figure 35. Plan of some proper configuration of structures (Aluminum Association, 2001).....	41
Figure 36. Some proper configurations (Eck, 2014).....	42
Figure 37. Schematic of some considerations for the welded joints (MP, 2005).	43
Figure 38. The cost versus expected service life of a coating applied by using various substrate preparation methods (Sharman, 2009).....	46
Figure 39. A vehicle which first sandblasted (left) and then primed and painted (right) (Chupas, 2014)..	48
Figure 40. Corrosion damage on a winter maintenance vehicle (a), and in-field success of UV curable coating (b) (Monty et al., 2014).	48
Figure 41. Before rebuild (left), after (right) (Chupas, 2014).....	53
Figure 42. Marine grade corrosion inhibitors can be used effectively for protecting brake valves, hydraulic fittings etc. (Chupas, 2014).....	61
Figure 43. Automated truck washing (Clonch, 2014; Chupas, 2014).....	62
Figure 44. Truck washing by hand with a power washer (Clonch, 2014; Chupas, 2014).	62

Figure 45. A relay and circuit breaker for spreader controls; mounted in the battery box (left), enclosed box inside the cab of the truck (right) (Smith, 2014).....	67
Figure 46. New lighting control module under the passenger seat (left), newly adopted lighting package (right) (Smith, 2014).....	67
Figure 47. Iowa type and direct cast spinners (left), and zero velocity spreaders (right) (Smith, 2014). ...	68
Figure 48. Corroded oil pans (left), and replaced by stainless steel (right) (Smith, 2014).	69
Figure 49. Understructure of stainless steel (Chupas, 2014).	69
Figure 50. Fluid Film applied to frame rails and undercarriage (Chupas, 2014; Fluid Film, 2014).....	70
Figure 51. ConnDOT Wheeled Loader from Caterpillar (Chupas, 2014).	70
Figure 52. ConnDOT auger system tray that bolts into the current sanding chain area of the body (Chupas, 2014).....	71
Figure 53. Western style understructure tri axle trucks used by ConnDOT (Chupas, 2014).....	71
Figure 54. An example of a corrosion management program (CPC, 2007).....	74
Figure 55. a & b) A new body treated with PRP CORSOL, then top coated with PRP Acrylic Urethane, c) a dump body after 5 years of use on a salt spreader truck (WSDOT & PRP, 2014).	75
Figure 56. Brake valves and glad hand treated with CORSOL prior to installation (WSDOT & PRP, 2014).....	75
Figure 57. a) A new wheel is stripped of its coating, treated with CORSOL, then top coated with PRP Hybrid Urethane, b) trailer wheels after 6 years (left) and in field success of COROSOL after 6 years (right) (Courtesy of PRP industries; WSDOT & PRP, 2014).....	76
Figure 58. A section of a bumper treated with PRP Corsol Metal Treatment System showing the bumper treatment test design (PRP, 2014).....	76
Figure 59. a) 60 APG cycles, b) 100 APG cycles, c & d) 150 APG cycles of Corsol system compared (left) to standard powder coat (right) (PRP, 2014).	77
Figure 60. The standard cylinder group on top compared to the PRP treated cylinders on the bottom (PRP, 2014).....	78
Figure 61. Mild Steel corrosion test (Shi et al., 2013).	98
Figure 62. Two set-ups which can be used for EIS measurements of coated metals for both long-term and short-term immersion tests (Monty et al., 2014; Schmidt et al., 2007).....	99
Figure 63. ASTM B117 test chamber and specimens as loaded into the salt spray (Shi et al., 2013).	100

Figure 64. Modified ASTM B117 and SAE J2334 test methods used for evaluating the effectiveness of salt neutralizer solutions (Monty et al., 2014).	101
Figure 65. ISO 20430 test procedure (Shi et al., 2013).....	102
Figure 66. Average corrosion creep after ISO 20340 and ASTM D5894 exposure (Sharman, 2009).	103
Figure 67. Durability test event (Ault, 1999).....	105
Figure 68. Examples of area percentages - a (ASTM D610 – 08).....	107
Figure 69. Examples of area percentages - b (ASTM D610 – 08).....	108
Figure 70. Examples of area percentages - c (ASTM D610 – 08).....	109
Figure 71. Reference photographs for different blister size (ASTM D714 – 02).	110
Figure 72. The sessile drops of a probe liquid with two different contact angles (θ) showing the hydrophobic and hydrophilic characteristics of the solid surfaces (UC Davis ChemWiki, 2014).	111
Figure 73. The best style for scribing the coated samples (ASTM D1654 – 08).....	112
Figure 74. Diagram of parallel-beam Glossmeter (ASTM D523 – 14).	112
Figure 75. Diagram of converging-beam Glossmeter (ASTM D523 – 14).	113
Figure 76. WBE in combination with SRET (Tan and Liu, 2013).	114
Figure 77. A schematic of the setup for mapping galvanic current and detecting potential noise over a WBE buried under insulation materials (Tan, 2011).	115
Figure 78. Coupled multielectrode sensors (left), and coupled multielectrode corrosion analyzer (right) (Sun, 2005).....	116
Figure 79. Impedance based sensor schematic (Sun, 2005).....	117
Figure 80. Theoretical Bode and Bode-Phase impedance plots for classification of polymer coating (Lee and Mansfeld, 1999).	118
Figure 81. Schematic drawing of Luna’s electrochemical reference sensor [Demo et al., 2009].....	119
Figure 82. An overview of the U.S. Marine Corps Corrosion Prevention and Control (CPAC) Program (Koch, 2010).	121
Figure 83. Inspection Tool (left) and Database (right) (Koch, 2010).	122
Figure 84. Total assets vs. corrosion category codes for 2004 and 2009 (Koch, 2010).	123
Figure 85. Corrosion Service Teams (Koch and Friend, 2009; Koch, 2010).	123

Figure 86. Fixed corrosion repair facilities (Koch and Friend, 2009).....	124
Figure 87. Mobile corrosion repair facilities (Koch and Friend, 2009; Koch, 2010).	125
Figure 88. Controlled Humidity Protection (Koch and Friend, 2009).....	125
Figure 89. Vapor Corrosion Inhibitor (VCI) Covers (Koch and Friend, 2009; Koch, 2010).	126
Figure 90. Accelerated corrosion testing (Koch, 2011).	127
Figure 91. A well prepared surface condition (Koch, 2011).....	127
Figure 92. Pretreatment (Koch, 2011).	128
Figure 93. Primer (Koch, 2011).	128
Figure 94. Topcoat (Koch, 2011).....	129
Figure 95. Steam and Water Jet Cleaning (Koch, 2011).....	129
Figure 96. Hydraulic components protected from corrosion using modified sealed protective covers (Shi et al., 2013).	133
Figure 97. Modified protective cover for a battery to reduce harmful effects of corrosion (left), and rubber caps on battery terminals used to mitigate effects of corrosion (right) (Shi et al., 2013).	133
Figure 98. New fuel tank made of aluminum (left), and modified electrical junction boxes which are mounted inside the cab off the floor (right) (Shi et al., 2013).	134
Figure 99. Corrosion of frame rails and components due to over filling of pre wet tanks (left) which is prevented by a vent tube that is installed from the top of the tank via a hose that exits below the frame rails (right) (Smith, 2014).	134
Figure 100. A 2007 corroded body (left), and a 2012 protected body by using a mix of weathering steel (Cor-Ten) and stainless steel (right) (Chupas, 2014).	134
Figure 101. In-field success of some corrective maintenance methods (Courtesy of RIDOT).	135
Figure 102. The corroded hydraulic piping (left) and the protected hydraulic piping by using stainless steel (right) (Chupas, 2014).	135
Figure 103. 2007 RPM box mounted under cab (left) and 2010 RPM box mounted behind driver seat (right) (Chupas, 2014).....	136
Figure 104. The various components enclosed in the valve body box are expensive and critical to the operation (left), the use of a sealed stainless steel enclosure will help prolong the life of these components (right) (Mills, 2012).	136

Figure 105. Electrical components in bad condition (left); ConnDOT requires body builders to provide sealed connections and plugs and use dielectric grease on them (right) (Chupas, 2014). 137

Figure 106. ConnDOT specification requires body builder to completely prime and paint with “Continental” 2 part urethane paint and primer (Chupas, 2014)..... 137

List of Tables

Table 1. Classification of dissimilar metals (Boeing, 2014). 8

Table 2. Estimated risk of equipment corrosion due to deicer exposure alone and annual costs of estimated equipment corrosion risks due to deicer exposure (Shi et al., 2013). 24

Table 3. Ranking the risk of metallic corrosion to the types of equipment the respondents’ agency owns (Shi et al., 2013). 27

Table 4. Ranking the risk of chloride deicers to various components of the agency’s vehicles/equipment (Shi et al., 2013). 28

Table 5. Common types of corrosion-prone material and their respective forms of corrosion seen in vehicles/equipment exposed to chloride deicers (Shi et al., 2013). 29

Table 6. Deicer listed by survey respondents as being used by their organization, showing frequency of use (Fay et al., 2008). 32

Table 7. Serviceability Rating used by the Federal Highway (FHWA, 2014). 51

Table 8. Two coat systems (Sharman, 2009). 102

Table 9. Scale and description of rust ratings (ASTM D610 – 08). 106

Table 10. A summary of some corrosion sensor technologies (Garosshen and Mukherji, 2000). 120

Appendix B: Test Methods and Online Monitoring Techniques for Anti-Corrosion Practices

In this section, specific testing methods and online monitoring systems will be presented. Two main topics include various test methods, and online monitoring techniques that provide valuable real time corrosion information.

B.1. Test Methods

In general, chloride solutions are one of the most corrosive solutions. In order to prevent corrosion from its extreme character, a variety of test methods to assess chloride corrosion to metals have been developed. Each method provides valuable results depending on the application. These test methods include: laboratory test methods, on site test methods, and online monitoring systems. In order to predict and manage corrosion damage, the original condition with respect to corrosion must be well-defined. In this regard, corrosivity of the environment and exposure time need to be measured. Accurate corrosion projections are difficult to obtain due to the nature and time involved with corrosion. While accelerated laboratory techniques are constantly changing in order to acquire accurate results that can be applied to real time situations, outdoor exposure testing is very time consuming (Kinzie, 2003).

B.1.1. Salt spray

The salt spray test is the most widely used corrosion assessment method (Granata, 2005). In the salt spray test, mild steel plates (size 150mm x 100mm x 2mm) are corroded in a salt spray chamber, following the steps shown in Figure 61.

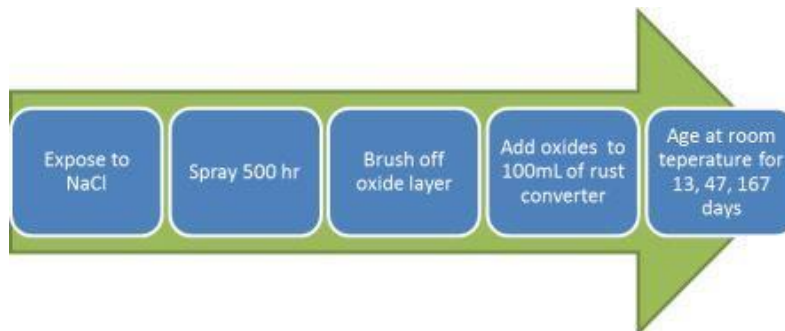

Figure 61. Mild Steel corrosion test (Shi et al., 2013).

The samples are then dried and undergo electrochemical testing. The electrochemical testing consists of electrochemical impedance spectroscopy (EIS) (Collazo, 2008 and 2010).

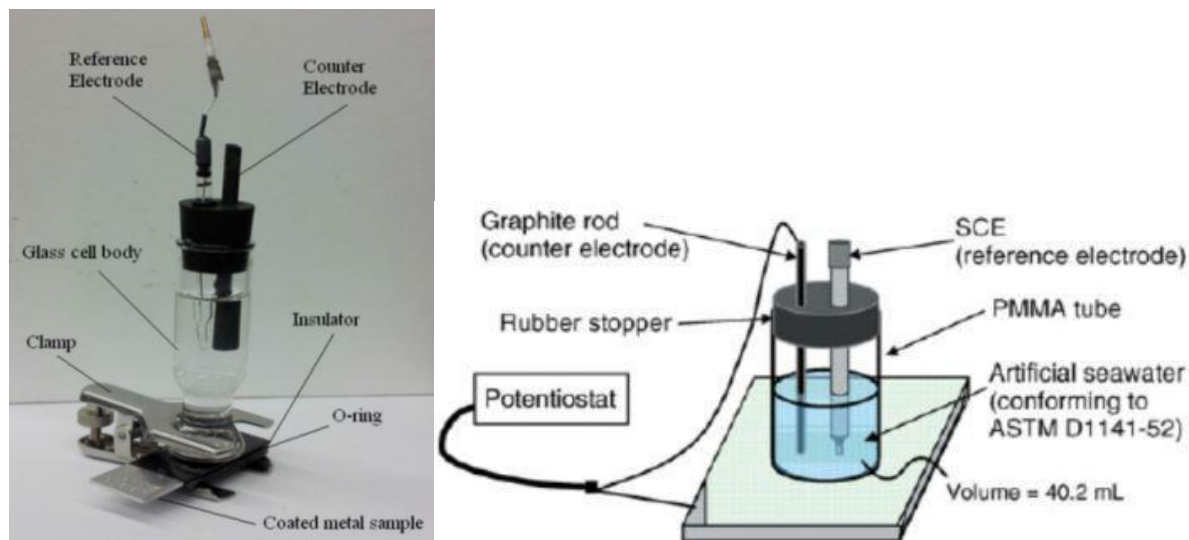

Figure 62. Two set-ups which can be used for EIS measurements of coated metals for both long-term and short-term immersion tests (Monty et al., 2014; Schmidt et al., 2007).

The following test method was used by Schmidt to test coatings (Schmidt et al., 2006). All tested coatings were applied to 10.2 cm x 15.2 cm x 0.32 cm ANSI 1018 flat steel panels. A scribe of 6.6 cm x 0.32 cm was marked into each of the samples at a depth of 0.064 cm and 0.015 cm on the continuous hot-dip samples. The samples were exposed on racks at an angle of 30° from horizontal, 25 m from the ocean and exposed to atmospheric conditions. Temperature, relative humidity, dew point, solar energy, wind speed and direction, time of wetness, rainfall, and chloride concentration were all recorded daily. These samples were exposed for 20 months. There were two replicates of each coating tested and they were analyzed 6 times. Pictures were taken and the samples were physically observed, and electrochemical tests were performed.

B.1.2 ASTM standard B117 and SAE J2334

ASTM standard B117 Salt Spray (Fog) Test involves a controlled laboratory exposure designed to accelerate results versus long-term outdoor exposure testing (Figure 63). In the B117 method a salt solution is sprayed as a mist on specimens in a constant temperature chamber. This test is considered to be an inaccurate representation of the corrosion mechanism due to the fact that the salt spray is continuously applied, which allows for no drying period. This drying period, which allows for the formation of protective layers, is critical in corrosion prevention. By comparison, an accelerated corrosion test method created by the Society of Automotive Engineers (SAE), SAE J2334, exposes metal specimens to changing climates over time in an enclosed chamber (Shi et al., 2013).

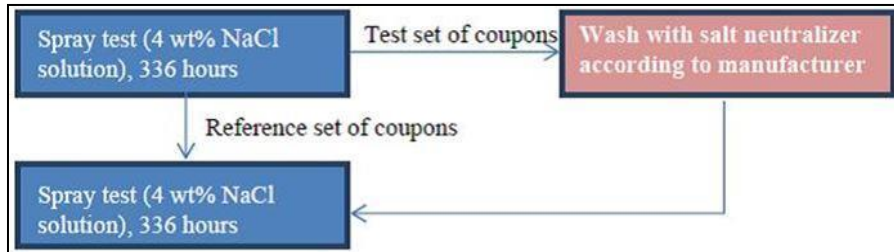

Figure 63. ASTM B117 test chamber and specimens as loaded into the salt spray (Shi et al., 2013).

The SAE J2334 test, uses a salt solution mixture of 0.5% NaCl, 0.1% CaCl₂ and 0.075% NaHCO₃ and consists of three stages: the humid stage with 6 hours of exposure at 50°C and 100% humidity, the salt application stage with a duration of 15 minutes at ambient conditions, and the dry stage with an exposure of 17 hours and 45 minutes at 60°C and 50% relative humidity. This test has been considered as an alternative for ASTM B117 because it utilizes a dry stage and has various corrosive ions in its spray solution. It also has been found that 80 cycles of the SAE J2334 test corresponds to 5 years of on-vehicle testing, which reduced the expense of outdoor testing. Atmospheric exposure is another test method used in the study of corrosion. It involves specimens set on racks at a 30° angle from the horizontal exposed to the ocean-front atmosphere. An exposure for a 24 month study period was used and temperature, relative humidity, dew point, solar energy, wind speed and direction, time of wetness, rainfall, and chloride concentration were recorded daily and measured six times throughout the exposure period. The results from this test method, and various other test methods did not correlate well with one another. However, when comparing the coating systems to one another for each test method, they were found to be effective and did correlate (Schmidt et al., 2007).

Monty et al. (2014) developed an accelerated ASTM B117 and SAE J2334 corrosion testing procedure for evaluating the effectiveness of salt neutralizer solutions according to the flow charts presented at Figure 64 (Monty et al., 2014).

Modified ASTM B117 test method



Modified SAE J2334 test method

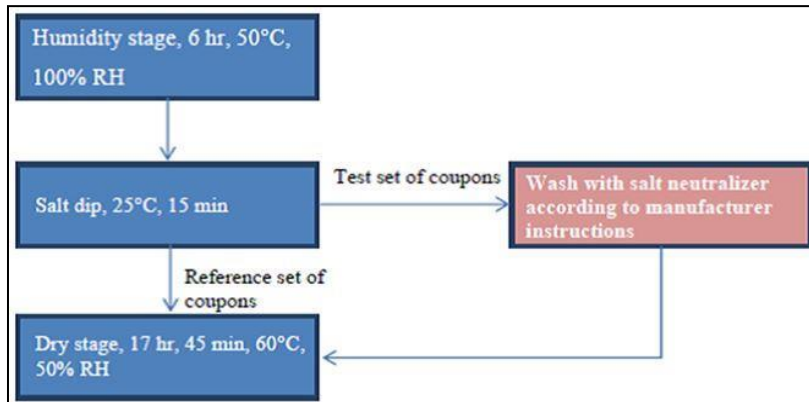

Figure 64. Modified ASTM B117 and SAE J2334 test methods used for evaluating the effectiveness of salt neutralizer solutions (Monty et al., 2014).

B.1.3 ISO 20430 and ASTM D5894

A study tested the difference between ISO 20430 and ASTM D5894 methods with two coating systems. Table 8 shows details of these systems. ISO 20430 test method is a cyclic corrosion test used to evaluate a coating system's performance for use in a marine environment classified as C5-M as per ISO 12944, Part 2 (shown in Figure 65) (Shi et al., 2013).

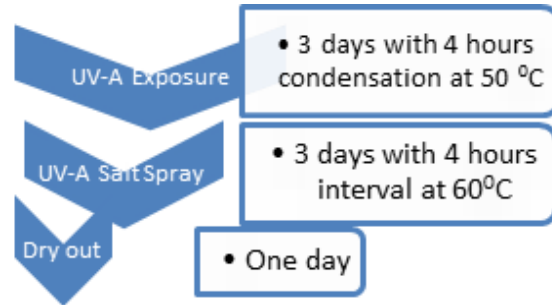

Figure 65. ISO 20430 test procedure (Shi et al., 2013).

Table 8. Two coat systems (Sharman, 2009).

System No.	Primer	Finish	Description	Dry Film Thickness Applied
1	Zinc Phosphate Epoxy	Zinc Phosphate Epoxy	A two Component, Low VOC, high solids, fast curing epoxy primer/finish containing zinc phosphate. Used for primer and finish	2 coats @ 7.9 mils (200 microns)
2	Surface Tolerant Epoxy	Surface Tolerant Epoxy	A low VOC, two component high build, high solids, surface tolerant epoxy maintenance coating. Used for primer and finish.	2 coats @ 7.9 mils (200 microns)
3	Modified Epoxy	Modified Epoxy	A two component, low VOC, high solids, modified epoxy barrier coat. Used for primer and finish	2 coats @ 7.9 mils (200 microns)

The ASTM D5894 is another cyclic corrosion test specific to industrial onshore environments. The coating test panels (Table 8) are exposed to UV-A for one week with 4 hours dry UV-A at 60°C and 4 hours condensation at 50°C as per ASTM G53 and prohesion salt spray (0.35% (NH₄)₂SO₄ and 0.05%NaCl) for one week with a one hour spray at 25°C and a one hour dry time at 35°C as per ASTM G85. The test panels were scribed with a horizontal cut into the coating system. In the immersion test method ISO 2812-2:2007, coated test panels are immersed in water. The panels are positioned such that 75% of the panel is immersed (Sharman, 2009).

As seen from the corrosion creep data shown in Figure 66, even in similar cyclic corrosion tests, there is substantial variability in the data. It has been proven that to achieve accurate data and avoid failure of a product once implemented, the best method for product assessment is to perform various test methods.

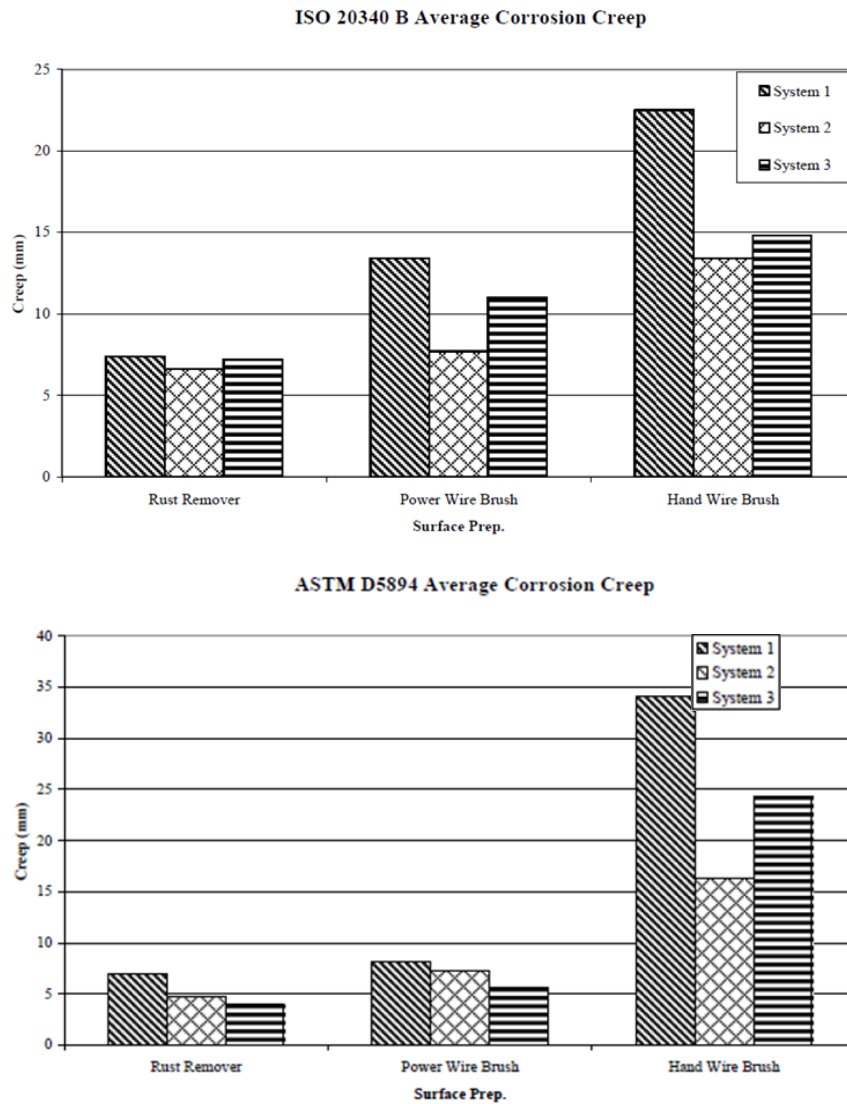

Figure 66. Average corrosion creep after ISO 20340 and ASTM D5894 exposure (Sharman, 2009).

B.1.4 PNS/NACE

The PNS/NACE test is another common method for investigating corrosion effects. It is a modification of the National Association of Corrosion Engineers (NACE) Standard TM0169-95 by the Pacific Northwest Snowfighters (PNS). This test method consists of applying 30 ml of a 3% chemical deicer solution per square inch on the surface of a coupon for testing. A cyclic immersion procedure is used with 10 minutes immersion in the solution and then 50 minute exposure to the air. This gravimetric method of multiple parallel coupons is continued for 72 hours. The results from the gravimetric method are expressed as the

average corrosion rate over a period of time. A percent corrosion rate (PCR) relating to the solution corrosivity is calculated from the weight loss. Electrochemical techniques are suggested as an alternative to gravimetric methods because corrosion mechanisms and kinetics data can be obtained in a timely manner (Shi et al., 2013).

B.1.5 SHRP H-205.7

A slightly different test approach is the SHRP H-205.7 test method, which was developed by the Strategic Highway Research Program (SHRP) to analyze the effectiveness of corrosion inhibiting additives in deicing products. This test method uses continuous immersion to evaluate the corrosive effects of deicers on metal. This test does not have a wet-dry cycle, which can be viewed as an inaccurate representation of field exposures, and requires long exposure times before weight loss data is collected (Chappelow et al., 1992).

B.1.6 Durability test

The US Army has long been affected by corrosion and its negative effects. Consequently, the US Army has developed an accelerated corrosion and durability test to collect corrosion and material performance data that can be related to service life of military vehicles in highly corrosive environments. This accelerated corrosion testing is based on tests developed by General Motors (GM). It has been found that the test has been able to simulate 10 years of cosmetic corrosion but only 3 years of crevice corrosion. It combines an accelerated corrosion test and a durability test that introduce typical input stresses, increasing the natural corrosion rates. The durability test event introduces typical situations encountered over the service life of the vehicle (Ault, 1999).

The application portion of the test includes a grit trough, salt mist, and humidity chamber. The grit trough allows small particles to accumulate on surfaces which increases time of wetness and provides abrasive particles to the coatings. The salt mist applies a high concentration salt solution to the vehicle, typical of roadways that contain deicing salts. The use of the high temperature and high humidity chamber increases the rate of corrosion (Figure 67) (Ault, 1999). Most corrosion tests result in cost savings through increased efficiency of observing corrosion effects. However with regard to the this experiment, researchers have found the long test period required to be a disadvantage. For example, salt spray accelerated test methods require 2000 hours of exposure and electrochemical measurements can take up to 10 weeks for results. Accelerated test methods like this have been proven to be very difficult to develop when time of failure needs to decrease while the failure mechanism remains the same.

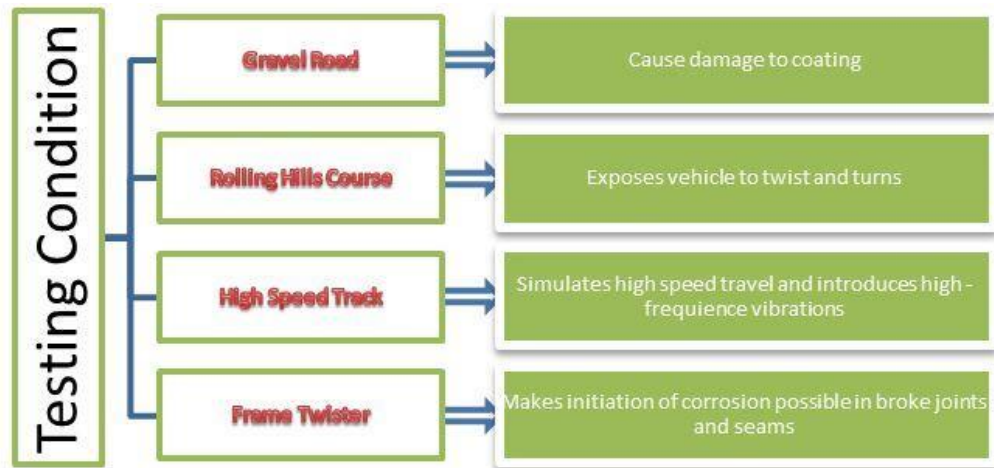

Figure 67. Durability test event (Ault, 1999).

Discoveries show that corrosion resistant performance can be obtained through thermal cycling paired with monitoring of low frequency impedance changes of coating systems. This technique provides a fast quantitative method to evaluate coating corrosion resistance, which leads to results obtained within a week of testing (Bierwagen et. al., 2000).

B.1.7 ASTM D610

ASTM D610 describes a method that is used to estimate the amount of rusting on the surface of coated steel. This standard does not include evaluation of rust propagation around an initially prepared scribe, score, or holiday. As shown in Table 9, the rust grade is ordered from 10 to 0 which is respectively equivalent to negligible rusting (less than or equal to 0.01 percent) and significant rusting (greater than 50 percent). Visual examples of various rust grades are presented in Figure 68 - Figure 70. In these figures, the rusting is divided in to three categories named as spot (S), general (G), and pinpoint (P) rusting. When the rusting is the mixture of these types, it will be named as hybrid (H) rusting (ASTM D610 – 08).

Table 9. Scale and description of rust ratings (ASTM D610 – 08).

Rust Grade	Percent of Surface Rusted	Visual Examples		
		Spot (s)	General (G)	Pinpoint (P)
10	Less than or equal to 0.01 percent		None	
9	Greater than 0.01 percent and up to 0.03 percent	9-S	9-G	9-P
8	Greater than 0.03 percent and up to 0.1 percent	8-S	8-G	8-P
7	Greater than 0.1 percent and up to 0.3 percent	7-S	7-G	7-P
6	Greater than 0.3 percent and up to 1.0 percent	6-S	6-G	6-P
5	Greater than 1.0 percent and up to 3.0 percent	5-S	5-G	5-P
4	Greater than 3.0 percent and up to 10.0 percent	4-S	4-G	4-P
3	Greater than 10.0 percent and up to 16.0 percent	3-S	3-G	3-P
2	Greater than 16.0 percent and up to 33.0 percent	2-S	2-G	2-P
1	Greater than 33.0 percent and up to 50.0 percent	1-S	1-G	1-P
0	Greater than 50 percent		None	

Rust Distribution Types:

S: Spot Rusting—Spot rusting occurs when the bulk of the rusting is concentrated in a few localized areas of the painted surface. The visual examples depicting this type of rusting are labeled 9-S through 1-S. (See Figure 68-Figure 70).

G: General Rusting—General rusting occurs when various size rust spots are randomly distributed across the surface. The visual examples depicting this type of rusting are labeled 9-G through 1-G. (See Figure 68-Figure 70).

P: Pinpoint Rusting—Pinpoint rusting occurs when the rust is distributed across the surface as very small individual specks of rust. The visual examples depicting this type of rusting are labeled 9-P through 1-P. (See Figure 68-Figure 70).

H: Hybrid Rusting—An actual rusting surface may be a hybrid of the types of rust distribution depicted in the visual examples. In this case, report the total percent of rust to classify the surface. 9-H through 1-H.

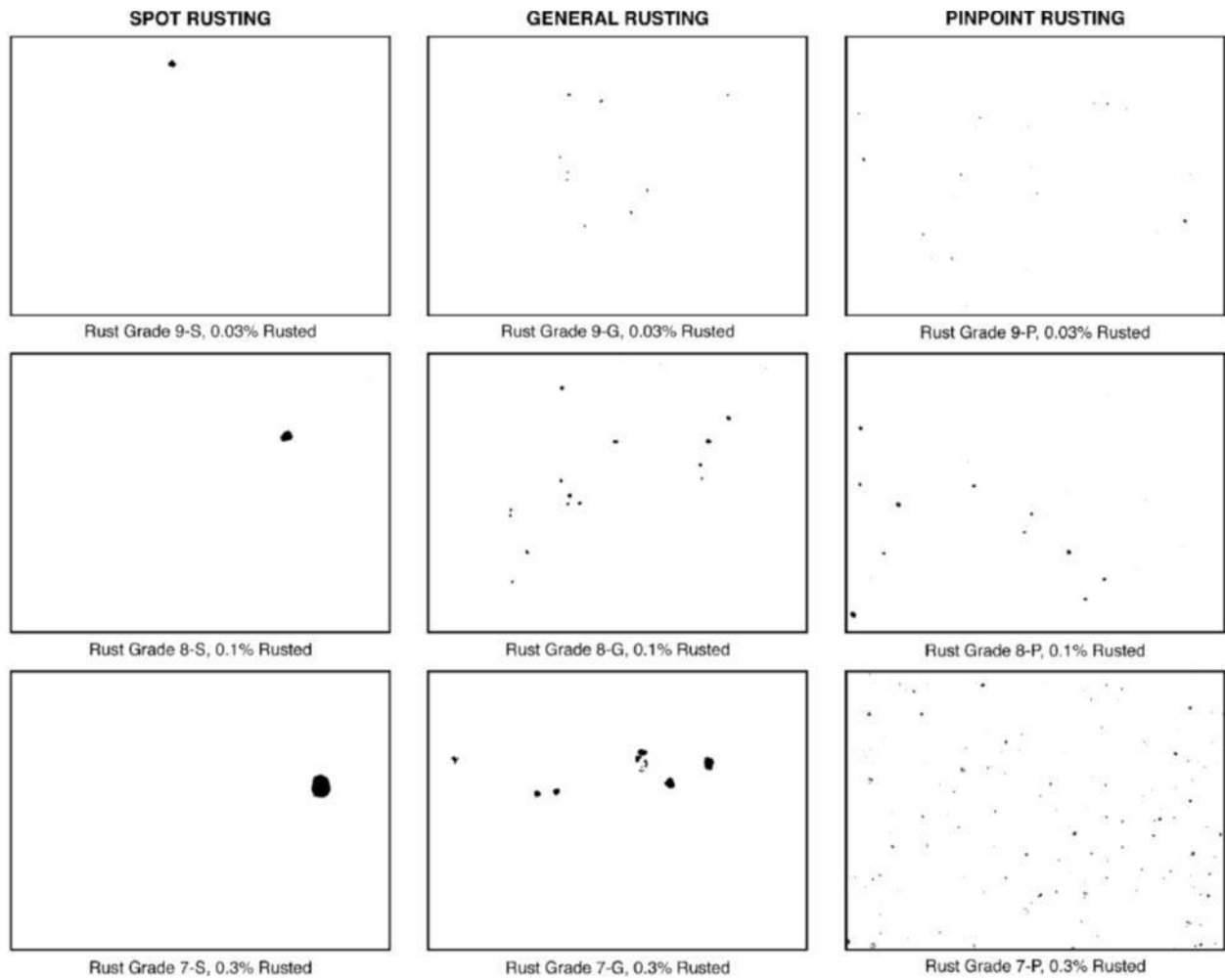

Figure 68. Examples of area percentages - a (ASTM D610 – 08).

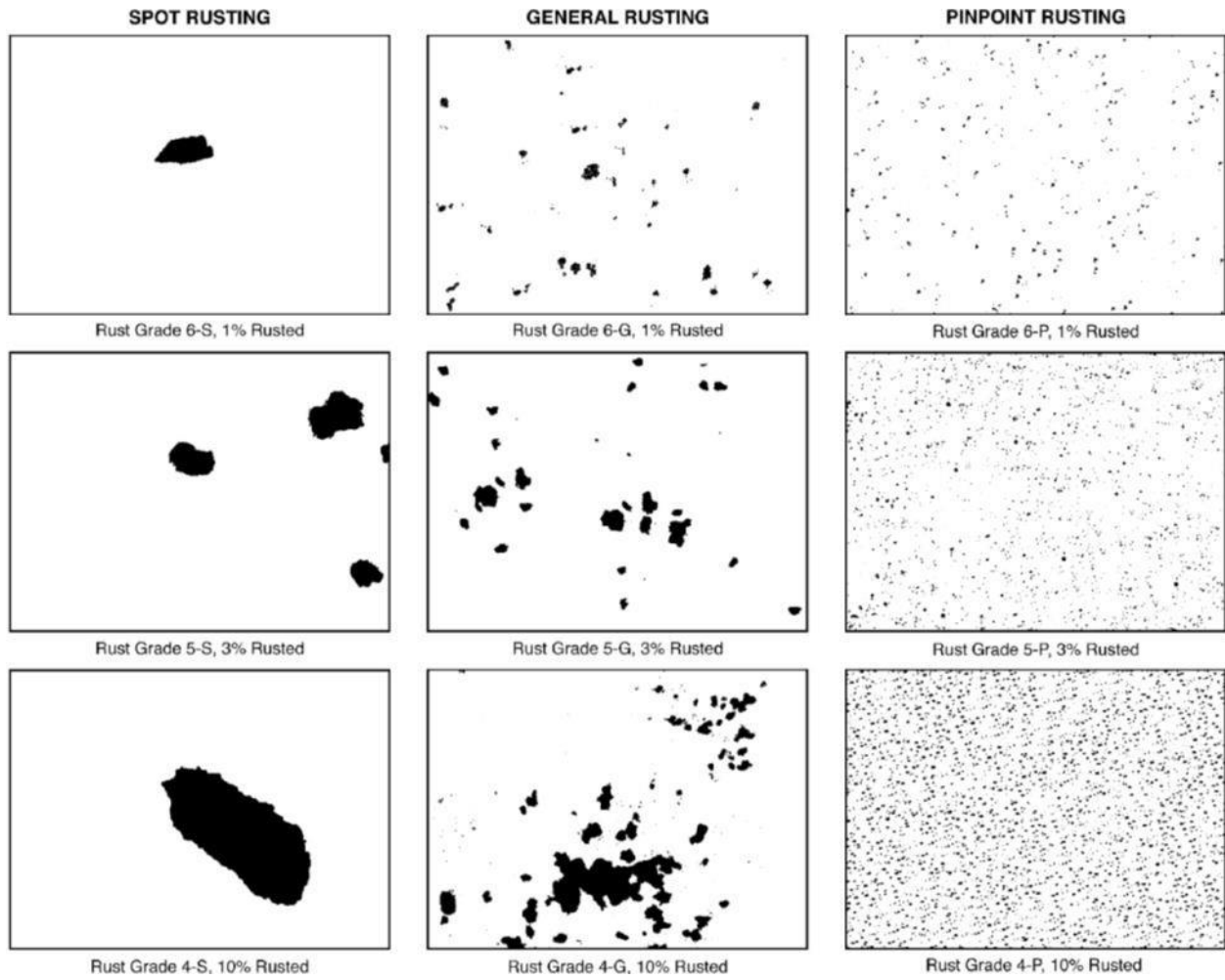

Figure 69. Examples of area percentages - b (ASTM D610 – 08).

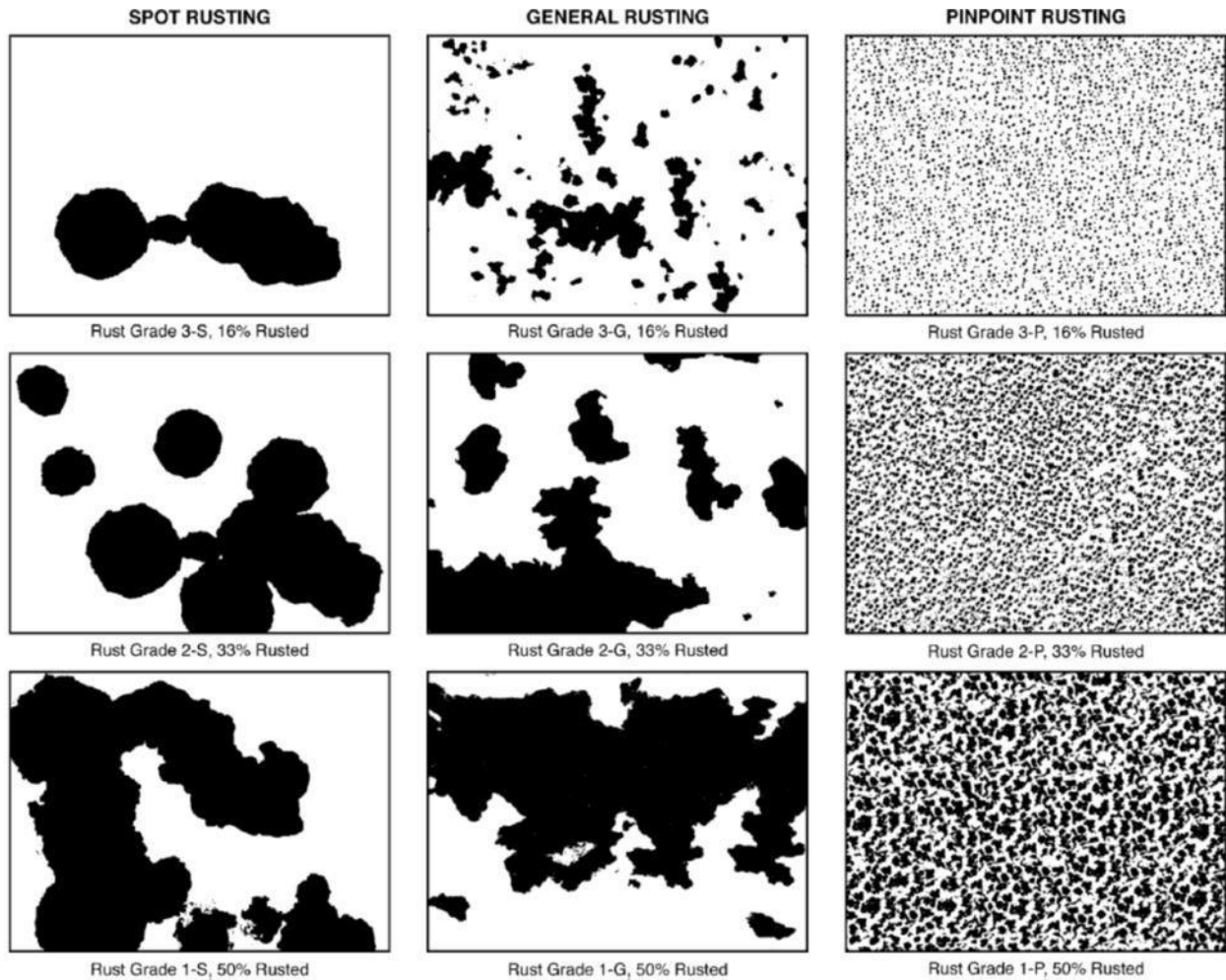

Figure 70. Examples of area percentages - c (ASTM D610 – 08).

B.1.8 ASTM D714

In this method the graphical reference standards are used to assess the degree of paint blistering caused by exposure in a corrosive environment. The application of this standard is not limited to metal and other nonporous surfaces, but it may also be used on porous surfaces, such as wood, if the size of blisters are within the range of these reference standards. The scales are rated from 10 to 0, in which number 10 shows no blistering. “Blister Size No. 8,” as shown in Figure 71 is attributed to those small blisters that can be seen easily by an unaided eye. The lower corrosion rating number, the larger the size of the blisters (ASTM D714 – 02).

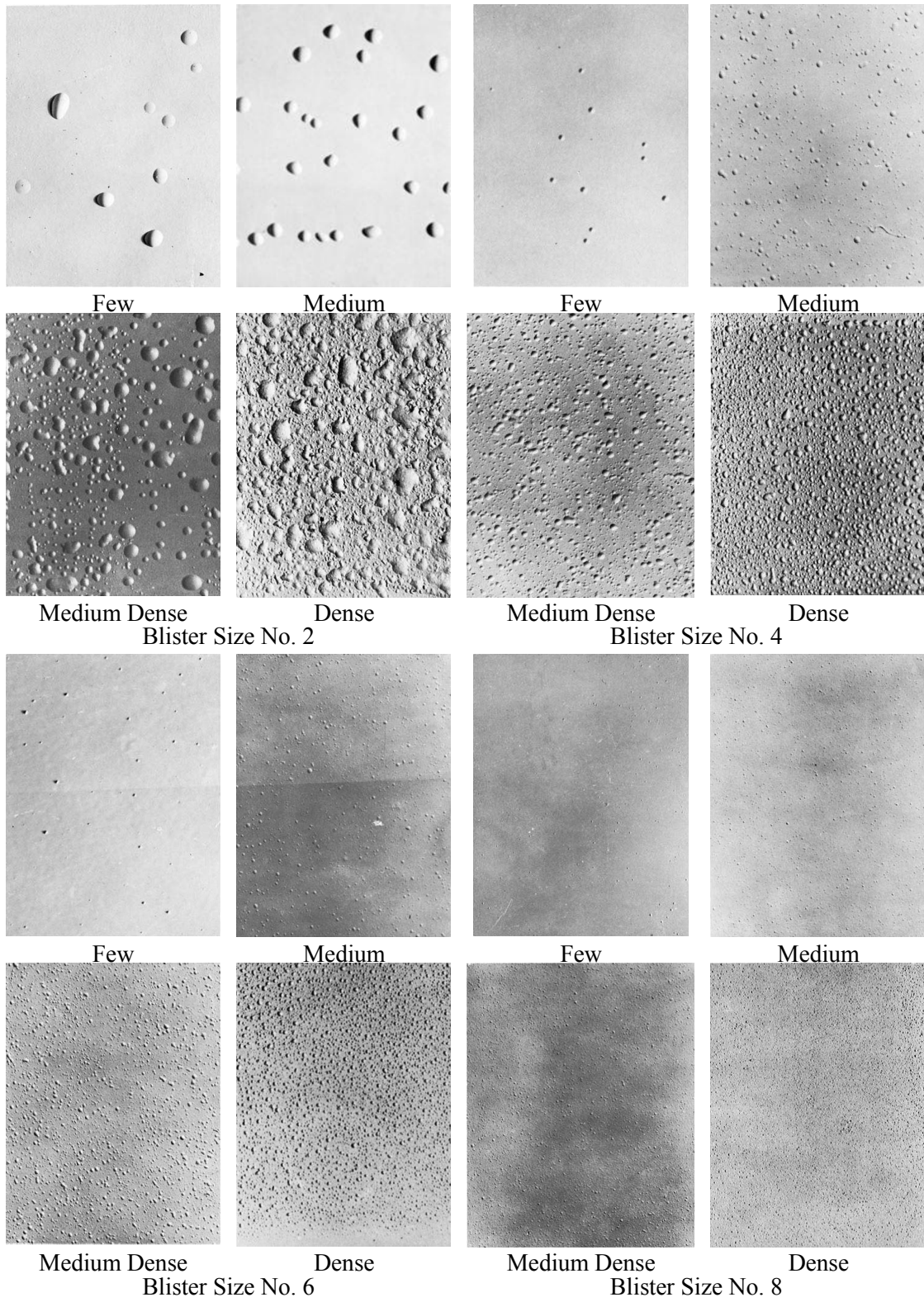

Figure 71. Reference photographs for different blister size (ASTM D714 – 02).

B.1.9 ASTM D2244

Paint color is an important factor in terms of both aesthetic value and safety. There are some parameters that can be used for calculating the overall color change of paints due to environmental exposure. In the equation shown below, “L*” is the “lightness” of color, which scores from light (white) to dark (black). The second parameter is “a*” that gets a positive value when the color becomes more reddish. On the contrary, “a*” receives a negative value if it becomes more greenish in color. The third parameter is the “b*”, which receives a positive value if it becomes more bluish and becomes negative when the color becomes more yellowish. General color alteration (ΔE) can be calculated by the following formula (ASTM D2244 – 11):

$$\Delta E = \sqrt{(\Delta L^*)^2 + (\Delta a^*)^2 + (\Delta b^*)^2}$$

Where:

$$\Delta L^* = L^*_{\text{Final}} - L^*_{\text{Initial}}$$

$$\Delta a^* = a^*_{\text{Final}} - a^*_{\text{Initial}}$$

$$\Delta b^* = b^*_{\text{Final}} - b^*_{\text{Initial}}$$

The ΔE equal to 1 is recognizable by the naked eye on a sunny day. The values of 2 and 3 appear similar on a cloudy day.

B.1.10 Contact Angle Measurements

The amount of attraction of a solution like water, corrosion inhibitor, or salt neutralizers on a metallic surface can be assessed by evaluating the wettability of the surface using contact angle measurements (Monty et al., 2014). As shown in Figure 72, by increasing the wettability, the contact angle will decrease. When a liquid drop makes a contact angle with the solid less than 90°, it would be a hydrophilic drop. On the other hand, when the contact angle is greater than 90°, it will be called a hydrophobic drop (UC Davis ChemWiki, 2014). The importance of the contact angle is that by increasing the wettability of the surface, the risk of corrosion damage will increase.

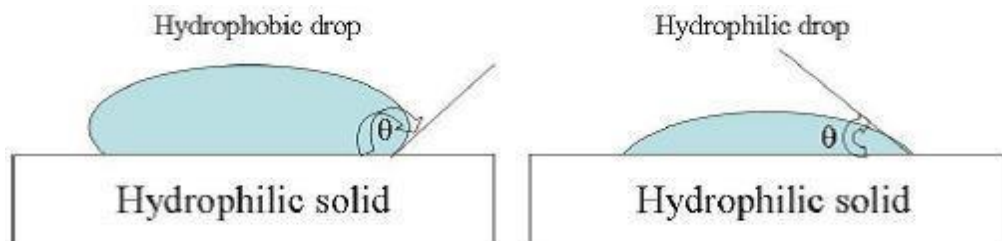

Figure 72. The sessile drops of a probe liquid with two different contact angles (θ) showing the hydrophobic and hydrophilic characteristics of the solid surfaces (UC Davis ChemWiki, 2014).

B.1.11 ASTM D1654

In this standard technique, the amount of rust creepage or undercutting of a coated material around a damaged area is used to evaluate painted samples subjected to corrosive media. To conduct the testing, a scribe is applied to the painted surface and then the scribed surface is exposed to the corrosive

environment. A special tool is used to scribe the samples and is shown in Figure 73. The angle between the tool and the surface of the sample is between 70 to 90°. The endpoints of the scribe should be at least 1.25 cm (0.5 in.) from the edge of the sample (ASTM D1654 – 08).

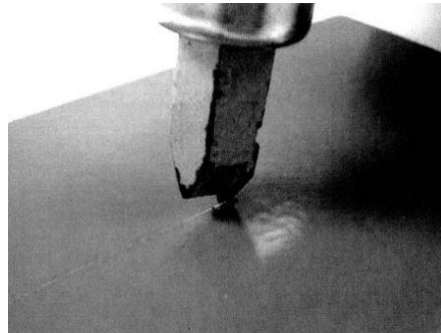

Figure 73. The best style for scribing the coated samples (ASTM D1654 – 08).

B.1.12 ASTM D523

This test method is a standard technique for determining the shininess, or “gloss”, of a sample. The amount of gloss is attributed to the ability of a surface to reflect the light in directions close to the receptor lens. In this method, an instrument called a Glossmeter (Figure 74 and Figure 75) measures the collected reflected light at three receptor angles, which are 20°, 60°, and 85° (ASTM D523 – 14).

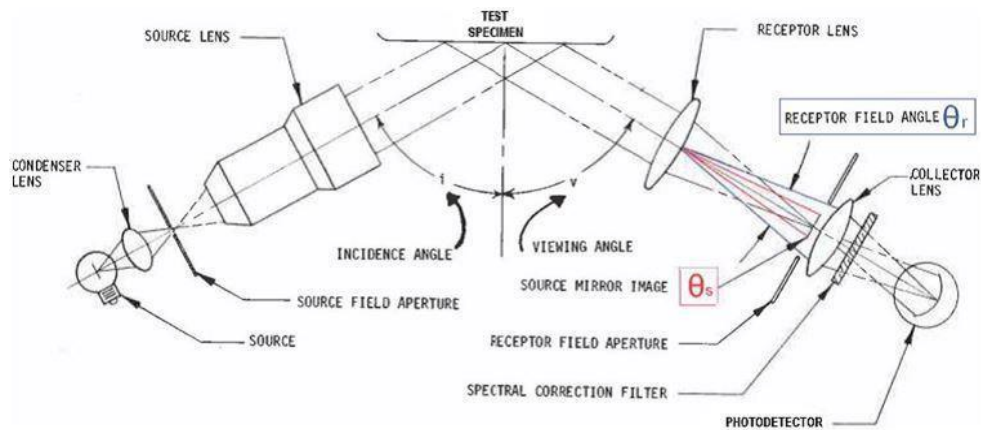

Figure 74. Diagram of parallel-beam Glossmeter (ASTM D523 – 14).

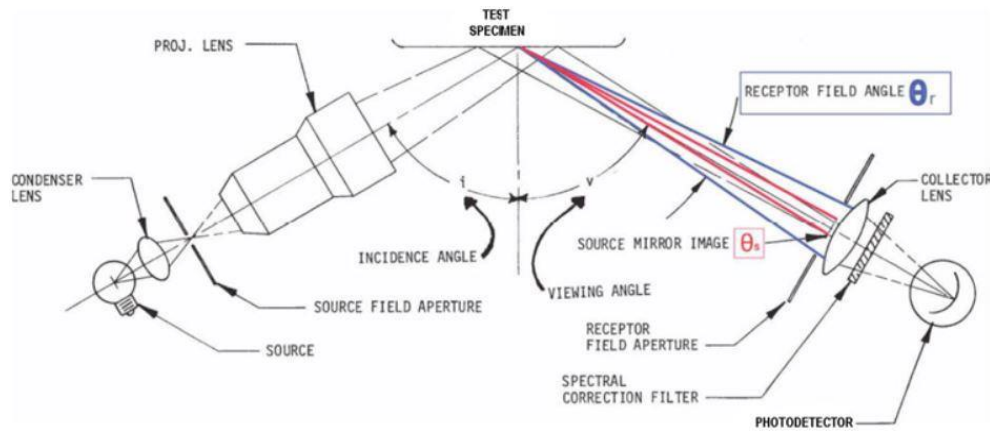

Figure 75. Diagram of converging-beam Glossmeter (ASTM D523 – 14).

B.1.13 Visual examination

In this method the samples are examined using a hand lens and/or low magnification field microscopes. A detailed report is prepared, describing the condition of the surface including all anomalies, cracks, corrosion damage, and the presence of foreign materials, erosion or wear damage, or evidence of impact or other distress. In addition, the condition of protective coatings should be considered. Manufacturing defects are important to note as well (Zamanzadeh, 2005).

B.1.14 Field Test Kits

Field test kits are available commercially for the detection of various corrosion causing agents, such as chlorides. The test kits provide an initial estimation of concentration, so that further more in-depth testing can be conducted if deemed appropriate.

B.2. Online monitoring

On-board/online monitoring systems are being developed to provide valuable real time corrosion information, which will aid in effectively reducing corrosion maintenance costs, offering alternative corrosion maintenance approaches, and improving safety standards. The typical schedule based approach for corrosion inspections can be replaced with a condition based approach. These systems are able to provide early detection and assessment of corrosion. Monitoring systems also can be used to estimate service life and assess performance of corrosion inhibitors.

B.2.1 Wire Beam Electrode (WBE)

Recently, a new system called the wire beam electrode (WBE) has been developed. The WBE uses a multi electrode technique which can be applied to corrosion studies. An electrochemically non-uniform metal surface occurs when a metal surface is exposed to an electrolyte causing localized defects in protective coatings and a polarization voltage across the surface. Galvanic corrosion current and corrosion potential are measured and used to assess the distribution of corrosion rates (Tan, 1998). In addition, this technique has the ability to be combined with the new in-situ electrochemical techniques such as the scanning reference electrode technique (SRET), as shown in Figure 76 (Tan and Liu, 2013).

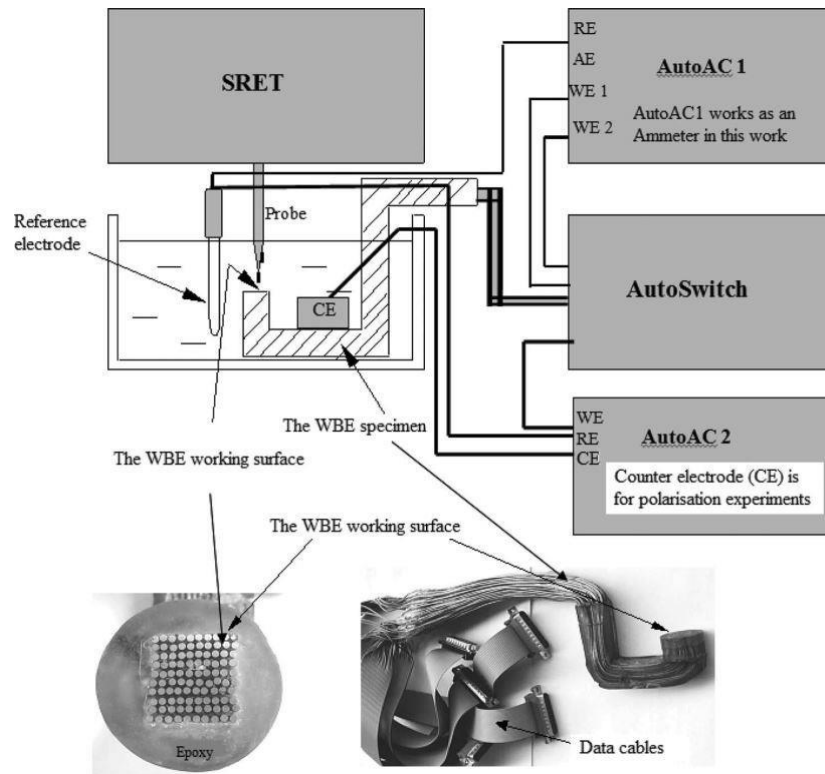

Figure 76. WBE in combination with SRET (Tan and Liu, 2013).

Crevice corrosion has been studied using traditional methods involving weight loss measurements and inspection, which provide details of mechanisms and processes. However, the wire beam electrode system is able to assess instantaneous corrosion rates (Tan et al., 2001). Electrochemical noise resistance coupled with wire beam electrode methods has offered advantages for determining corrosion rate and patterns. The noise resistance is defined as the ratio of the standard deviations of potential noise versus the actual measured noise.

As shown in the schematic in Figure 77, the noise resistance has been found to be equivalent to the polarization resistance, and can therefore be used to determine rates of corrosion (Tan, 2003 and 2011). It was determined that the time-average noise resistances from stainless steel coupled multielectrode array sensors provided a good relationship with solution corrosivity (Yang et al., 2005).

Wire beam electrodes can also be used to collect data from various environments to estimate the pitting sensitivity of metals. The results demonstrated that materials, solutions, and exposure time affect the potential range of the wire beam electrode. It was exhibited that as the NaCl concentration increased logarithmically, the potential ranges of the wire beam electrode increased linearly. It was also determined that in NaCl solutions carbon steels had less pitting sensitivity than stainless steels, although carbon steels were generally more susceptible to corrosion. Data collected included potentials, galvanic currents, and impedance. This technique of using wire beam electrodes to assess pitting corrosion was concluded to be more accurate than traditional methods (Weng, 2004).

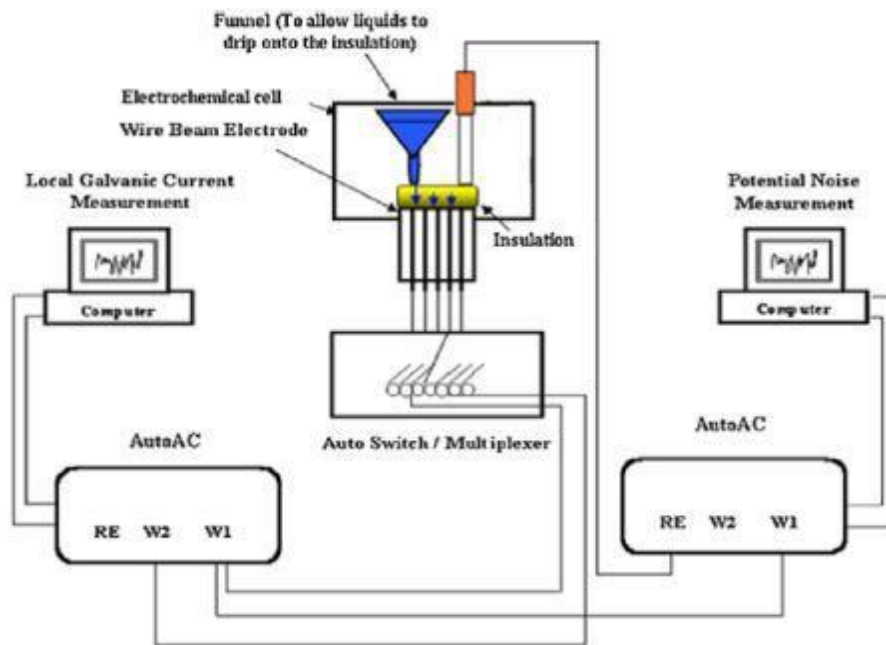

Figure 77. A schematic of the setup for mapping galvanic current and detecting potential noise over a WBE buried under insulation materials (Tan, 2011).

With advancements in material science, engineering, and testing methods, many improvements have been made to corrosion protective systems in recent decades. However, developing accurate accelerated test methods remains a major challenge. It has been found that correlations between coating performance and electrical properties offer valuable information on the mechanisms of corrosion and possible new corrosion testing techniques. Corrosion potential, DC resistance, AC impedance at room temperature, AC impedance as a function of temperature, current flowing through coatings at high potential, repetitive cathodic polarization, cathodic delamination, and current/time measurements can also provide valuable information related to corrosion rate and performance (Leidheiser, 1991).

B.2.2 Coupled multielectrode corrosion sensors

Corrosion under a coating is difficult to detect, and a reliable monitoring system that can provide real-time evaluation of coating performance is needed. For example, coupled multielectrode corrosion sensors and a multielectrode corrosion analyzer can be used as an online monitoring system to study the corrosion under coatings. In some experiments different commercial coatings were applied to the electrodes and some electrodes were scratched to simulate defects. The electrodes were then exposed to a salt solution. Based on these tests, the coupled multielectrode system was found to be as effective as an online corrosion monitoring system for coating performance (Figure 78). The high sensitivity of the sensors enabled obtaining early warnings before failure of the coatings were observed (Sun, 2005).



Figure 78. Coupled multielectrode sensors (left), and coupled multielectrode corrosion analyzer (right) (Sun, 2005).

B.2.3 Impedance sensors

Sensor networks that use under coatings can also decrease the costs of replacement and inspection if implemented early in the design stage. An advantage of using these sensor networks includes continuous monitoring. An advantage of using impedance sensors is that it directly detects degradation and can detect moisture absorbed by a coating (Davis et al., 2000) (Figure 79 and Figure 80). Impedance based sensor technology was presented as a monitoring system to track the degradation of coating systems. The use of a single high frequency perturbation provided fast collection of large volumes of data for analysis. Bayesian techniques were used to process the data and provide more accurate results while reducing errors caused by noise and sensor failures. Issues with this technique occurred when corrosion was present but impedance values remained high, which was caused by coating failure at an edge; therefore a clear understanding of the system is critical in the evaluation of the data (Dante et al., 2007). It has been shown that the sensitivity of the sensor varies with the frequency at which the data is collected. Mote based sensor technologies offered on-board monitoring and wireless data transmission (Jakab et al., 2008).

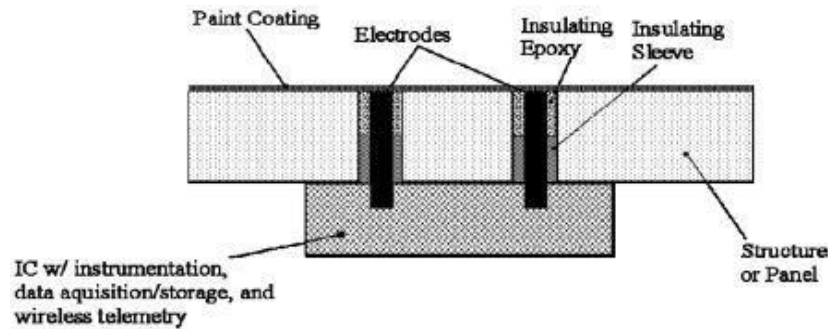

Figure 79. Impedance based sensor schematic (Sun, 2005).

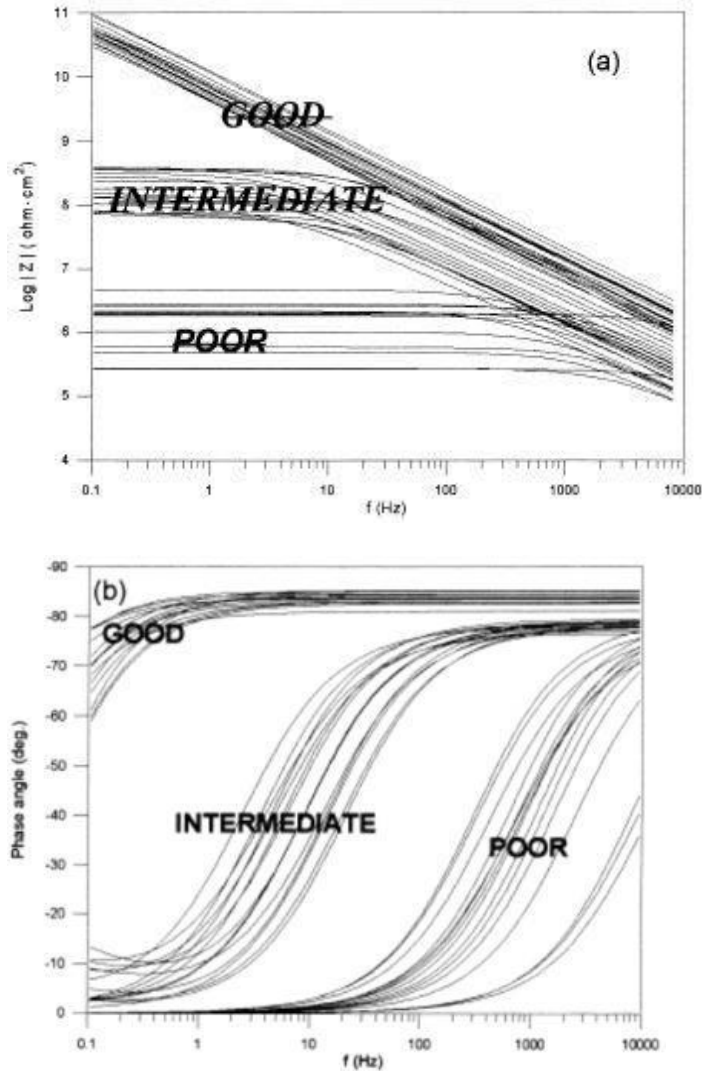

Figure 80. Theoretical Bode and Bode-Phase impedance plots for classification of polymer coating (Lee and Mansfeld, 1999).

B.2.4 Bimetallic corrosion sensor

NAVAIR developed an analysis of a bimetallic corrosion sensor, which involves a simple bimetallic sensor composed of different thin films of metal. Suggested advantages of this method include the simple design and user-friendly real time data system (Garosshen and Mukherji, 2000). The system is composed of transducer interface modules and a network capable of processing applications that monitor, record, and analyze data from environmental and corrosion sensors. This method has been applied in aircraft corrosion monitoring. The system is capable of not only measuring and evaluating the corrosiveness of the environment but also the corrosion of the structure. The sensors are equipped for measuring environmental factors such as temperature, relative humidity, time of wetness and electrochemical potential, which provides useful corrosion information. The corrosion monitoring sensors are capable of directly measuring the instantaneous corrosion rates. This is accomplished by obtaining linear

polarization resistance measurements that are integrating over time to provide the total corrosion to the material (Figure 81) (Demo et al., 2009).

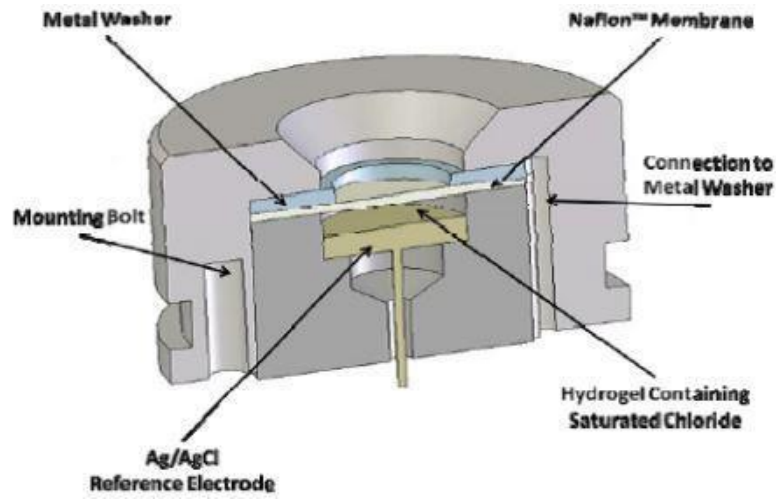

Figure 81. Schematic drawing of Luna's electrochemical reference sensor [Demo et al., 2009].

While sensor technology is improving, Ayello et al. studied three different techniques for the detection of corrosion: the direct impedance measurements, the galvanic couple with active RFID tags, and the Wi-Fi based motes with 2 wire electrodes. Each technique was analyzed for its ability to detect corrosion under insulation. Impedance measurements were found to indirectly predict corrosion under insulation through time of wetness. The Wi-Fi based sensors were determined to have many advantages over other detection techniques, including continuously collecting data, storing information for remote access, and facilitating the installation of systems (Ayello et al., 2011).

Online corrosion monitoring technologies have played an important role in decreasing corrosion damage and associated failures, while increasing accuracy of data. Field corrosion monitoring consists of either a technique in which collective corrosion damage measurements are obtained or measurements of dominant corrosion rates are taken. The accumulated loss techniques indicate change only when an adequate amount of corrosion has occurred, which will change the bulk material properties; therefore, these systems are not used with online monitoring methods. However advances in multi-technique systems have increased accuracy by providing multiple measurements within the system. These quantitative corrosion measurements can be delivered using the same communication methods, and they provide critical data for process control and optimization. By assessing the corrosion current, the direct result of the instantaneous corrosion process, the rate of metal loss can be determined (Kane et al., 2005).

Numerous sensor types are being developed to detect corrosive conditions. Table 10 includes a summary of different sensor types. There are a variety of approaches for detection of corrosive conditions, including simple resistance measurements or complex electrochemical measurement techniques. “To be of practical value, a corrosion sensor system must: (1) be reliable/durable, (2) be cost effective, (3) provide output that correlates to real corrosion damage, (4) be user friendly, (5) not create significant additional maintenance costs, and (5) not interfere with operation. It cannot be over emphasized that a sensor system must be robust and provide accurate information about corrosion issues in real world applications” (Garosshen and Mukherji, 2000).

Table 10. A summary of some corrosion sensor technologies (Garosshen and Mukherji, 2000).

Sensor Type	Principle of Operation
Bimetallic Thin Film Galvanic Sensor	Galvanic corrosion current between two dissimilar metals is measured by a ZRA.
Electrical Resistance (ER) Probes	Resistance change of metallic thin films is measured via ohmmeter data logger.
Linear Polarization Resistance (LPR)	Micro reference, working & counter electrodes to measure linear polarization resistance.
Bragg Grating Fiber-Optic Corrosion Sensor	Stress change in optical fiber occurs when metal coating corrodes. This changes fiber's refractive index and causes optical signal modulation.
LPR/ER Corrosion Sensor	Combines LPR and ER techniques into one sensor package to enable cross-referencing.
Micro Corrosion Sensor Array	Combines micropotentiostat and ZRA on a small chip to measure corrosion rate of real metallic sample versus environment.
Micro Ion-Selective Corrosion Sensor	Utilizes micro pH, chloride, and free potential electrodes to measure corrosion rate of aluminum sample.
Fiber Optic Fluorescence Corrosion Sensor	Detects light that is emitted from fiber coating that undergoes fluorescence in presence of corrosion products.
Fluorescence Paints	Paints containing additives that exhibit fluorescence under UV light in presence of corrosion products such as Al^{+3} .
Test Coupons	Metal coupons in aircraft are periodically examined for extent of corrosion visually and via weight loss measurements.

Appendix C. U.S. Marine Corps Corrosion Prevention & Control Plan

This chapter reviews a successful Corrosion Prevention and Control Plan (CPCP) that has been used by the U.S. Marine Corps, under the title of U.S. Marine Corps Corrosion Prevention and Control (CPAC) Program - Marine Corps Order 4790.18 (Koch and Friend, 2009; Koch, 2010 and 2011).

The goal of the program was to develop and execute an effective CPAC program to prolong the useful life of all Marine Corps ground equipment (Koch and Friend, 2009; Koch, 2010). The objectives of the CPC program were to “mitigate the impact of corrosion through a comprehensive CPAC Program using:

- Existing Assets: through assessment, treatment and prevention.
- New Procurements: implement corrosion control in the design, testing, and prototype stages.
- Research and Development / Engineering: develop better products and processes to combat corrosion” (Figure 82) (Koch, 2010).

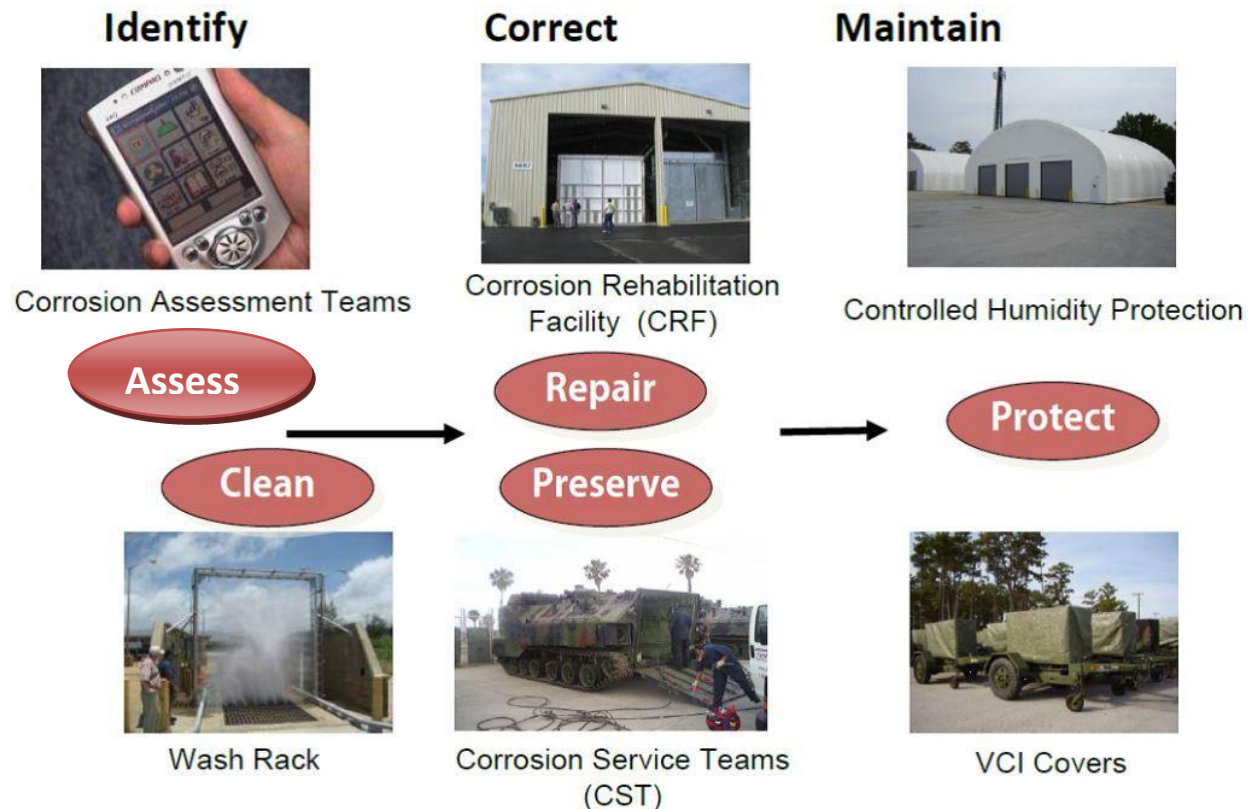

Figure 82. An overview of the U.S. Marine Corps Corrosion Prevention and Control (CPAC) Program (Koch, 2010).

C.1. Corrosion Category Code Definitions

The following corrosion categories were developed for assessment and data collection purposes.

“Category 1: Item requires no corrosion repair or preservatives, and has been assessed within the past 6 months. The goal at this level is to maintain the item as a category 1.

Category 2: Item requires surface preparation, spot paint, and preservation at the operator and/or organizational level. The goal of this effort is to return the item to category 1.

Category 3: Item requires maintenance performed beyond the operator level. Spot painting has arrested the corrosion, but the item is now in a condition that requires complete repainting and overcoat. The item must be inducted to the C3 program for repair. The goal of this effort is to induct the item into the C3 program so that it will return the unit to a category 1 condition.

Category 4: Item requires repair to sheet metal, major frame components, paint, blasting and undercoating (e.g., replacement or repair of components such as doors, fenders, and chassis frame rails, or battery boxes due to corrosion). The goal of this effort is to immediately induct the item into the C3 program so that it will return the unit to a category 1 condition.

Category 5: The item is degraded to a degree that requires depot level repair and replacement based on the deterioration caused by corrosion” (Koch and Friend, 2009; Koch, 2010).

C.2. Inspection Tool and Database

An inspection tool and database were developed utilizing the above mentioned category codes, which are described in more detail below.

- “Data is taken via handheld PDA and uploaded into CPAC database.
 - Checklist identifying corrosion-prone areas (Category 1 - 5).
- Database is updated weekly and reports are available from CPAC website” (Figure 83) (Koch, 2010).



Figure 83. Inspection Tool (left) and Database (right) (Koch, 2010).

After running CPAC for 5 years, the percentages of vehicles in corrosion category codes 1 and 2 were increased significantly, which shows a meaningful decrease in corrosion damage (Figure 84).

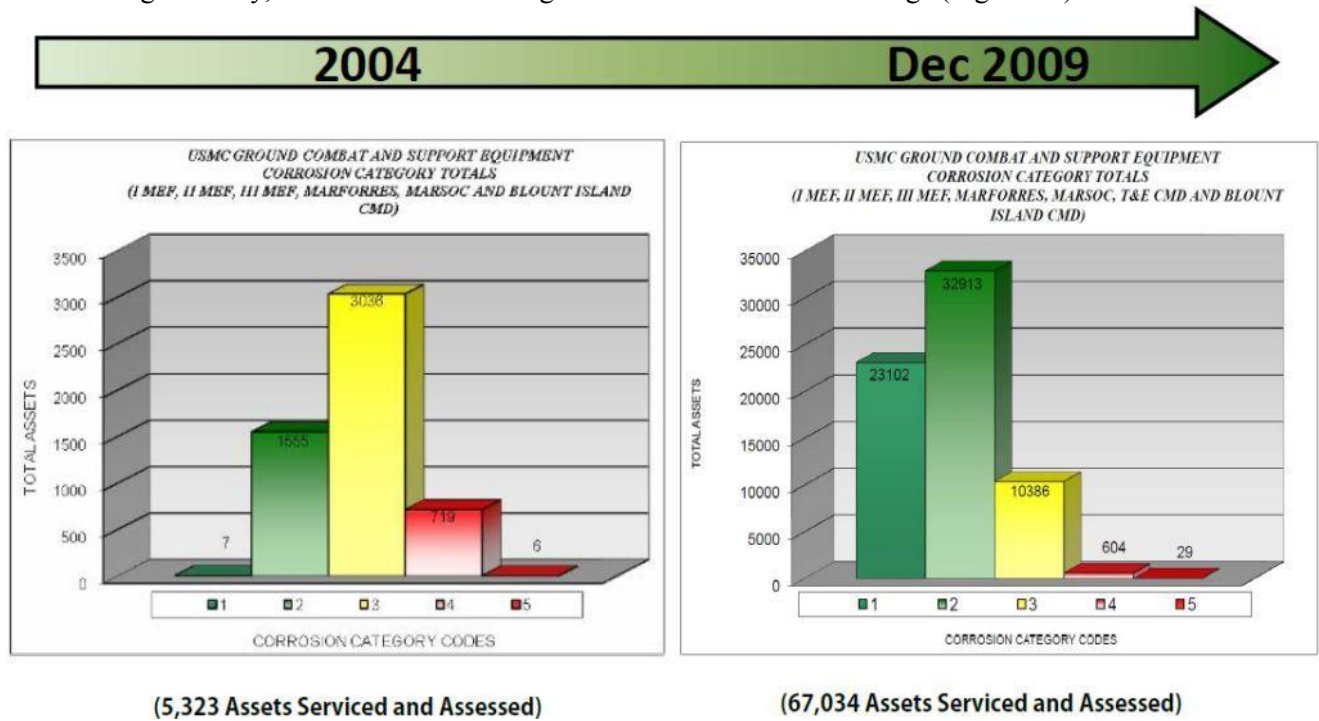

Figure 84. Total assets vs. corrosion category codes for 2004 and 2009 (Koch, 2010).

C.3. Corrosion Repair and Facilities

To conduct the identified corrosion repairs, corrosion service teams (CST) were established. All CST teams at marine camps follow the “Organizational Level maintenance IAW TM-4795-12” (Figure 85) (Koch and Friend, 2009).



Figure 85. Corrosion Service Teams (Koch and Friend, 2009; Koch, 2010).

The CST operated at fixed corrosion repair facilities (CRF). The fixed facilities for CRF conduct onsite blasting, and repair of vehicles and support equipment (Figure 86) (Koch and Friend, 2009).



Figure 86. Fixed corrosion repair facilities (Koch and Friend, 2009).

Mobile facilities for corrosion repair were also established to provide temporary on-site surface preparation and painting (Figure 87) (Koch and Friend, 2009). The mobile facilities are used primarily in remote locations, such as on reserves, to supplement the fixed facilities.



Figure 87. Mobile corrosion repair facilities (Koch and Friend, 2009; Koch, 2010).

C.4. Corrosion Prevention

Humidity control structures were identified as a corrosion prevention technique. Vehicles and equipment are stored in or under controlled humidity protection, or covered by vapor corrosion inhibitor covers (Figure 88 and Figure 89) (Koch and Friend, 2009; Koch, 2010).



Figure 88. Controlled Humidity Protection (Koch and Friend, 2009).



Six Con Fuel Pump Cover



MTVR Dash Cover



Generator Covers



HIMARS Cover

Figure 89. Vapor Corrosion Inhibitor (VCI) Covers (Koch and Friend, 2009; Koch, 2010).

C.5. Contract Wording

Contracts with vehicle vendors should include the following content (Koch and Friend, 2009):

- “Define required service life in operational environment.
- Contractor must provide Corrosion Prevention Plan (CPP) during System Development and Design (SDD) phase.
- Required testing of processes and products detailed in CPP.
- Full system testing during LRIP - Combination of RAM and Corrosion Events to identify system capabilities.
- Follow-on production audits and field surveys to ensure that contractor is following CPP.
- DoD Series 5000.67 all ACAT 1 programs must form Corrosion Prevention Advisory Teams (CPAT).”

C.6. CPCP Example: Joint Light Tactical Vehicle (JLTV)

This section summarizes how the CPCP was used for a Joint Light Tactical Vehicle (JLTV).

Accelerated corrosion testing was used because it was identified as the best, commercially available method for evaluating the corrosion resistance of fasteners, parts, components, and subsystems (Koch, 2011). Testing of the fasteners, parts, components, and subsystems consisted of **176 cycles of the SAE J2334 or the GMW 14872 (replaces GM 9540P) laboratory accelerated corrosion** (Figure 90) (Koch, 2011).



Figure 90. Accelerated corrosion testing (Koch, 2011).

The surface condition was assessed thoroughly, because the surface condition greatly affects the adhesion of painting systems (Koch, 2011). For surfaces that were intended to be painted, the condition, profile, and cleanliness of the surface should meet MIL-DTL-53072 requirements. For surface preparation, workmanship must be consistent with best commercial practices (i.e., commercial automotive), such that “base materials (i.e., substrates) should be free of cracks, burrs, sharp edges, and weld spatter that may affect the corrosion performance and coating adhesion” (Figure 91) (Koch, 2011).



Figure 91. A well prepared surface condition (Koch, 2011).

Surface pretreatment should be considered as it enhances the corrosion protection of subsequent coating systems (Koch, 2011). When using pretreatments, ensure they are compatible with the cleaning method and the primer used, including but not limited to conversion coatings (i.e. phosphate coatings), or other organic or inorganic materials. Application of such pretreatments should be performed in accordance with all of the manufacturer’s recommendations (Figure 92) (Koch, 2011).

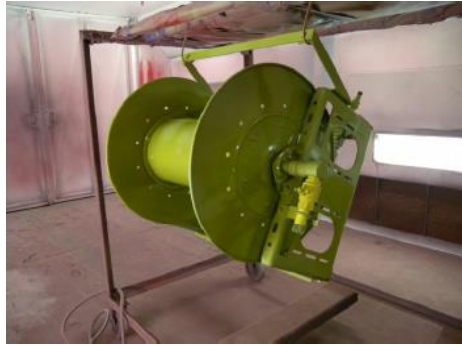

Figure 92. Pretreatment (Koch, 2011).

“Primers provide the majority of corrosion protection for coating systems and are of critical importance” (Koch, 2011). For CPCP applications, primers should meet the following requirement: MIL-DTL-53072 or in the case of e-coating, MIL-DTL-53072 or CID A-A-52474 (Figure 93) (Koch, 2011).



Figure 93. Primer (Koch, 2011).

Topcoats provide a barrier to water and contaminants and are a critical first layer of defense in fighting corrosion. Topcoats need to be compatible with other components of a surface treatment, particularly the primer (Koch, 2011). For CPCP, topcoat should meet the MIL-DTL-53072 requirements. Following application of topcoats, units should be inspected for surface imperfections, total film thickness and adhesion. The minimum dry film thickness (DFT) should be the sum of the minimum thickness specified by MIL-DTL-53072. The frequency and location of DFT per unit measurements and the repair procedure for deficiencies shall meet CPCP standard protocols (Figure 94) (Koch, 2011).



Figure 94. Topcoat (Koch, 2011).

Steam and water jet cleaning should be performed following surface treatment to ensure that the barrier provided by the painting system is not breached by normal cleaning procedures (Koch, 2011). The JLTV and all its components should be able to withstand cleaning with high-pressure steam or water jet cleaner (2500-3000 psi) at a distance no closer than 0.3 meters (1 ft) to any surface, compatible with A-A-59133 without deterioration (Figure 95) (Koch, 2011).



Figure 95. Steam and Water Jet Cleaning (Koch, 2011).

“Water entrapment provides an ideal environment for the promotion of corrosion, and must be avoided wherever possible. For this reason, the JLTV should be designed to avoid water collection and entrapment during manufacturing, operation, storage, and transportation orientations. Where cavities are unavoidable, functional drain holes of adequate number, size, and shape shall be provided at the lowest possible location during operations and storage. Drain holes shall not interfere with the structural integrity of the JLTV” (Koch, 2011).

“Debris can entrap moisture providing an environment for corrosion, while debris in areas with moving parts can erode the topcoat and provide a path for corrosion. For this reason, the JLTV should be designed to avoid the collection of debris, dirt, grime, and other matter to which the JLTV may be exposed during normal operations. Where collection points are unavoidable due to other design considerations, access shall be provided for cleaning and removal of debris” (Koch, 2011).

“Galvanic corrosion associated with dissimilar metal contact is greatly enhanced in a seawater/salt spray environment and must be avoided wherever possible. For this reason, the JLTV should be designed to avoid the potential for galvanic corrosion. The galvanic series in seawater presented in ASTM G82 may be used as a guide to determine materials compatibility. Specific methods for isolating dissimilar materials should be documented in the CPCP and in the process/finish specification(s). The contractor shall itemize and provide drawings and materials of construction for all joints susceptible to galvanic corrosion” (Koch, 2011).

Appendix D. Fleet Composition and Replacement Example Audit

The following is an excerpt from an audit and assessment of the Washington D.C. Fire and Emergency Medical Services Department's fleet inventory and maintenance operations to further improve fleet management. Though it focuses on fire trucks and ambulances most of the findings and recommendations readily apply to the snow and ice control fleets of Public Works and DOT agencies (DC Fire and EMS, 2014).

*“The FEMS Fleet is composed of 369 vehicles and other motorized and non-motorized equipment. The apparatus inventory we conducted **revealed a fleet that is aging, showing signs of excessive wear-and-tear, and in overall poor condition that is reflective of years of hard, urban emergency driving compounded by unstructured and deferred preventative maintenance and repairs.** As one might expect, newer apparatus were found to be generally in better shape than older apparatus, but even newer apparatus often had maintenance issues. Given how hard FEMS works its apparatus (a function of call volume, road conditions, and driving behaviors), **it can be concluded that the apparatus will fail unless it is adequately maintained for the entirety of its service life. In addition to being well maintained, apparatus must be replaced when it has reached the end of its serviceable life. Failing to replace apparatus as needed causes the frequency, cost, and difficulty of maintenance and repair to soar and proves to be an impediment to servicing other, more functional apparatus.***

*Based on the previous experience of the Project Team in assessing and auditing other fire and EMS agencies' fleets of similar size and composition, our analysis of the FEMS fleet demonstrates that a sizable portion of both the **frontline and reserve units** are in subpar condition in relation to these comparable departments. At FEMS, **units frequently undergo repeated repairs for the same or similar problems.** As a group, reserve truck companies are in especially poor condition. EMS transport vehicles comprise the largest class of vehicles in the fleet. Given that they are worked almost non-stop, it is little surprise that the **older EMS units (the current Ford ambulances) are in bad shape, both in terms of physical and engine condition. These units fail regularly and, as a class, account for the largest portion of work performed by the Shop.** In fact, the current Ford ambulances account for almost the same amount of mechanics' effort as do all engines, trucks, and squads combined.*

It is recommended that FEMS implements a reserve fleet that is capable of providing high-quality backup apparatus to replace frontline apparatus taken out of service for either maintenance or repairs. In order to ensure that a full complement of apparatus is available to support the Department's current deployment plan, we recommend an aggressive apparatus replacement plan that acknowledges the high call volume and heavy demands placed on the apparatus and the unique responsibilities and demands that are an outgrowth of the role FEMS plays in protecting the Nation's capital. This plan calls for engines, trucks, and squads that have no more than 7 years in frontline service, another 3-4 years in “ready reserve” service, and a final 3-4 years in reserve service, for an average total service life of between 13 and 15 years.

Ambulances would serve a total of 3 years in frontline service, another 2 years as either a “ready reserve” or special events unit, and another 2 years in reserve service, for an average total service life of

7 years. Passenger vehicles and SUVs should be replaced approximately every 7 years, based on the actual condition and usage of the vehicle.

Apparatus replacement should follow a consistent schedule which spreads new acquisitions over time, rather than the current practice of acquiring vehicles in spurts, which produces peaks and valleys in the collective aging of the fleet. Ensuring a consistent, but smaller, number of apparatus is procured each year will result in the vehicle replacement budget and the overall maintenance and repair effort being evened out. Going forward, apparatus replacement should not be deferred to achieve short-term budgetary savings, because such savings are accomplished at a long-term cost – having to catch up in later years or face winding up with a fleet in equally bad shape.”

Appendix E. Additional Practical Examples of Replaced or Modified Equipment to Reduce Corrosion

Figure 96 - Figure 106 show additional examples of how transportation agencies and manufacturers have replaced or modified equipment to reduce the effects of corrosion on fleet vehicles.



Figure 96. Hydraulic components protected from corrosion using modified sealed protective covers (Shi et al., 2013).



Figure 97. Modified protective cover for a battery to reduce harmful effects of corrosion (left), and rubber caps on battery terminals used to mitigate effects of corrosion (right) (Shi et al., 2013).



Figure 98. New fuel tank made of aluminum (left), and modified electrical junction boxes which are mounted inside the cab off the floor (right) (Shi et al., 2013).

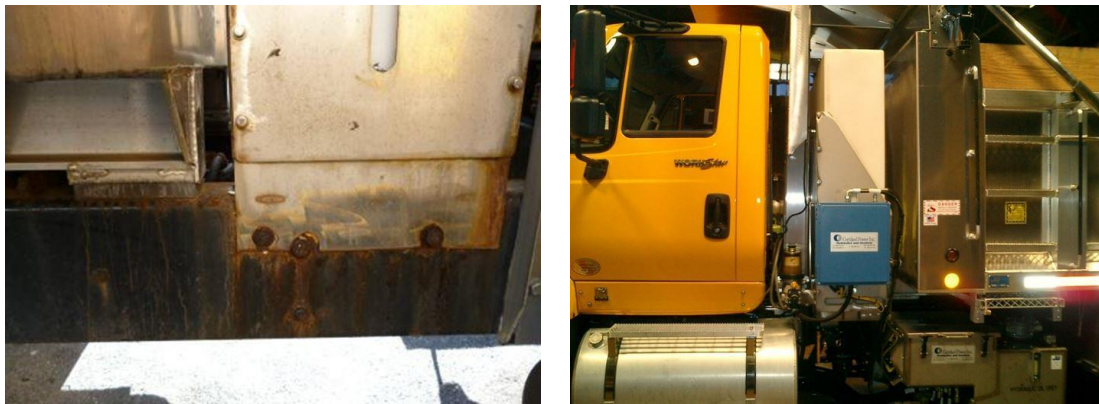

Figure 99. Corrosion of frame rails and components due to over filling of pre wet tanks (left) which is prevented by a vent tube that is installed from the top of the tank via a hose that exits below the frame rails (right) (Smith, 2014).



Figure 100. A 2007 corroded body (left), and a 2012 protected body by using a mix of weathering steel (Cor-Ten) and stainless steel (right) (Chupas, 2014).

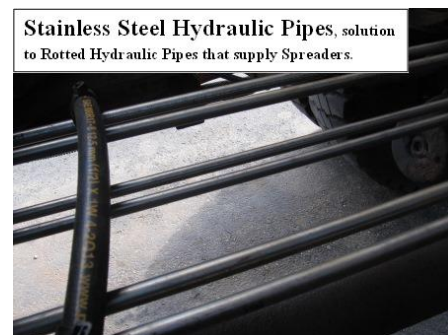
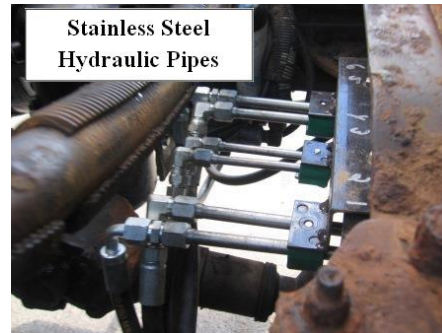
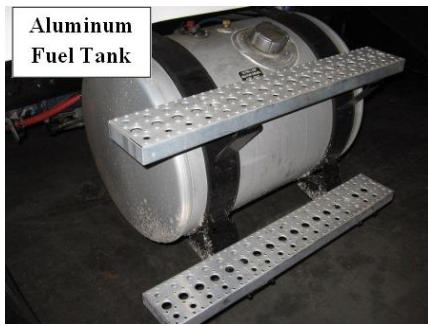

Figure 101. In-field success of some corrective maintenance methods (Courtesy of RIDOT).

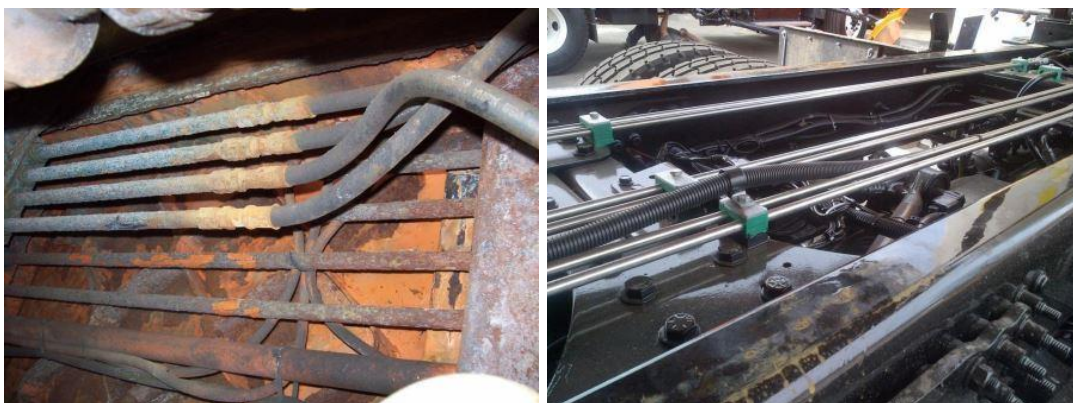

Figure 102. The corroded hydraulic piping (left) and the protected hydraulic piping by using stainless steel (right) (Chupas, 2014).



Figure 103. 2007 RPM box mounted under cab (left) and 2010 RPM box mounted behind driver seat (right) (Chupas, 2014).



Figure 104. The various components enclosed in the valve body box are expensive and critical to the operation (left), the use of a sealed stainless steel enclosure will help prolong the life of these components (right) (Mills, 2012).



Figure 105. Electrical components in bad condition (left); ConnDOT requires body builders to provide sealed connections and plugs and use dielectric grease on them (right) (Chupas, 2014).



Figure 106. ConnDOT specification requires body builder to completely prime and paint with “Continental” 2 part urethane paint and primer (Chupas, 2014).